

de

Filter

en

Filters

fr

Filtres

it

Filtri

es

Filtros

nl

Filters

sv

Filter

cs

Filtry

pl

Filtry

ru

Фильтры

Angebot · Offer · Offre · Offerta · Oferta ·
Assortiment · Offert · Nabídka · Oferta · Ассортимент

NEW

A 2



A 8



A 10



A 15



A 22



A 37

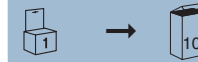

A 42



A 44



A 46



A 54

Verwendung · Applications · Affectations · Impiego · Aplicaciones ·
Gebruiksdeel · Användningsdel · Použití · Zastosowanie · Применение

B 2



B 674



B 958



B 972



B 975



Gegenüberstellung · Cross-reference · Table de correspondance · Comparazione ·
Equivalencias · Opzoektabel · Jämförelse · Převod · Zamienniki · Сопоставления

A...Z → Bosch

C 2

→ Bosch

C 110





de

Woran erkennen Sie erstklassige Qualität? An der neuen Bosch-Verpackung.

- ▶ Einfache Wiedererkennung
- ▶ Schnelle und zielgerichtete Produktauswahl durch Produktabbildungen auf den Verpackungen
- ▶ Hohe Stabilität
- ▶ Umweltfreundliche Verpackung

en

The mark of top-class quality: the new Bosch packaging.

- ▶ Easily recognized
- ▶ By providing an image of the product on the package, the right product can be selected quickly.
- ▶ High stability
- ▶ Environmentally friendly packaging

fr

À quoi reconnaît-on une qualité d'exception ? Au nouvel emballage Bosch.

- ▶ Reconnaissance simple
- ▶ Choix de produits rapide et ciblé grâce à des illustrations des produits sur les emballages.
- ▶ Grande solidité
- ▶ Emballage respectueux de l'environnement

it

Come riconoscere una qualità eccellente? Dalla nuova confezione Bosch.

- ▶ Riconoscimento semplice
- ▶ Selezione prodotto mirata e veloce grazie alle immagini del prodotto sulla confezione.
- ▶ Elevata stabilità
- ▶ Confezione altamente ecocompatibile

es

¿Cómo reconoce usted la calidad de primera? En el nuevo embalaje de Bosch.

- ▶ Reconocimiento sencillo
- ▶ Selección rápida y precisa del producto gracias a las imágenes que aparecen en los embalajes.
- ▶ Alta estabilidad
- ▶ Embalaje ecológico

nl

Hoe herken je eerste klas kwaliteit ? De nieuwe Bosch verpakking.

- ▶ Eenvoudige erkenning
- ▶ Snel en doelgericht selecteren van producten dankzij productafbeeldingen op de verpakkingen.
- ▶ Hoge stabiliteit
- ▶ Milieuvriendelijke verpakkingen

sv

Hur ser du att kvaliteten är förstklassig? På den nya Bosch-förpackningen.

- ▶ Lätt att känna igen
- ▶ Snabbt och ändamålsenligt produktval med hjälp av produktbilder på förpackningarna.
- ▶ Hög stabilitet
- ▶ Miljövänlig förpackning

cs

Při uznání kvalita prvotřídní? V novém Bosch Packaging.

- ▶ Jednoduchý re-uznání
- ▶ Rychlý a cílený výběr produktu díky vyobrazení produktu na obalech.
- ▶ Vysoká stabilita
- ▶ Ekologická verze balení

pl

Po czym rozpoznać najwyższą jakość? Po nowym opakowaniu Bosch.

- ▶ Łatwa identyfikacja
- ▶ Ilustracje na opakowaniu umożliwiają szybki i precyzyjny wybór produktów.
- ▶ Wysoka stabilność
- ▶ Ekologiczne opakowanie

ru

По какому признаку можно определить первоклассное качество? По новой упаковке от Bosch.

- ▶ Легкая узнаваемость
- ▶ Быстрый и точный выбор продукта благодаря его изображению на упаковке.
- ▶ Высокая стабильность
- ▶ Экологичная упаковка

de Kombiniertes Bestellnummernsystem	en Combined part number system	fr Système combiné de références	it Sistema di codice combinato	es Sistema combinado de referencias
nl Een gecombineerd bestelnummersysteem	sv Kombinerat ordernummersystem	cs Kombinovaný systém objednávacích čísel	pl Nowy system numerów katalogowych	ru Комбинируемая система нумерации артикулов

Typ					Type
3.2 V6					
176 936A000 <M10>	10.03→	0 451 10 P 3351	O		
		1 457 43 S 3791	L		
	2FE	1 987 43 R 2386 ^B	I		
V					
V 1.8 T.S. 16V					
106 AR 32201 <M1>	05.98-12.00	0 451 10 P 3300	O		
	KL	1 987 43 M 2014	I		
V 2.0 JTS					
121 937A1.000 <M8>	04.03-07.04	0 451 10 P 3336	O		
	04.03-12.05	KL 1 987 43 M 2014	I		
V 2.0 T.S. 16V					
110 AR 16201 <M1>	04.95-04.98	0 451 10 P 3300	O		
		0 450 90 F 5087 ¹	K		
110 AR 32310 <M6>	08.00-12.05	0 451 10 P 3300	O		
		1 987 43 M 2014	I		
114 AR 32301 <M2>	05.98-07.00	0 451 10 P 3300	O		
		0 450 90 F 5087 ¹	K		
		1 987 43 M 2014	I		

A Trockenmittelbox	A Desiccant box
C Kühlwasserfilter	C Coolant filter
D Denox Filter Service Set	D Denox filter Service set
H Hydraulikfilter	H Hydraulic filter
I Innenraumfilter	I Filter for vehicle interior
K Kraftstofffilter	K Fuel filter
L Luftfilter	L Air filter
O Ölfilter	O Oil filter
P Filter, Lenkhilfepumpe	P Filter, power steering pump
S Ölabscheider	S Oil separator
A Cartouche de déshydratant	A Box essiccante
C Filtre à liquide de refroidissement	C Filtro liquido di raffreddamento
D Kit d'entretien filtre Denox	D Kit di manutenzione filtro Denox
H Filtre hydraulique	H Filtro idraulico
I Filtre d'habitacle	I Filtro per l'abitacolo
K Filtre à carburant	K Filtro carburante
L Filtre à air	L Filtro dell'aria
O Filtre à huile	O Filtro olio
P Filtre, pompe d'assistance de direction	P Filtro, pompa servosterzo
S Séparateur d'huile	S Separatore d'olio
A Caja de agente desecante	A Droogmiddelbox
C Filtro de agua de refrigeración	C Koelwaterfilter
D Set de servicio de filtro Denox	D Denox-filterserviceset
H Filtro hidráulico	H Hydraulisch filter
I Filtro de habitáculo interior	I Interieurfilter
K Filtro de combustible	K Brandstofffilter
L Filtro de aire	L Luchtfilter
O Filtro de aceite	O Oliefilter
P Filtro, dirección asistida	P Filter, stuurbe-krachtigingspomp
S Separador de aceite	S Olieaafscheider
A Torkmedelsbox	A Krabice s vysoušecím prostředkem
C Kylvätskefilter	C Filtir chladicí vody
D Denox filter servicesats	D Servisní sada filtru Denox
H Hydraulfilter	H Hydraulický filtr
I Kupéfilter	I Filtr pro vnitřní prostor
K Bränslefilter	K Čistič paliva
L Luftfilter	L Čistič vzduchu
O Oljefilter	O Čistič oleje
P Filter, styrservopump	P Filtr, čerpadlo posilovače řízení
S Oljeavskiljare	S Odlučovač oleje
A Skrzynka osuszająca	A Коробка с сушильным агентом
C Filtr wody chłodzącej	C Фильтр охлаждающей жидкости
D Zestaw serwisowy filtra denox	D Сервисный комплект для фильтров Denox
H Filtr cieczy hydraulicznej	H Гидравлический фильтр
I Filtr wnętrza pojazdu	I Фильтр для салона
K Filtr paliwa	K Топливный фильтр
L Filtr powietrza	L Воздушный фильтр
O Filtr oleju	O Масляный фильтр
P Filtr, pompa wspomagania kierownicy	P Фильтр, насос усилителя рулевого привода
S odolejacz	S Маслоотделитель

0 451 10**P3300**

=



№

P3300

+



0 451 103 300



0 450 905 287	CITROEN	Berlingo 1.1 i
1 457 434 184	AUDI	A4 (B5) 1.9 TDI
1 457 434 408	FORD	Transit FT 080 2.5 D
F 026 402 048	ALFA ROMEO	GT 1.9 JTD 16V
F 026 402 059	NISSAN	Cabstar 2.5 D Turbo
F 026 402 093	OPEL	Astra H 1.7 CDTI
F 026 402 101	VW (VOLKSWAGEN)	Crafter 2.5 TDI
F 026 402 103	MERCEDES-BENZ	Serie A (169) 160 CDI
F 026 402 104	MERCEDES-BENZ	Sprinter 210 CDI
F 026 402 106	BMW	Serie X1 (E84) X 1 16 d sDrive
F 026 402 108	NISSAN	Qashqai 2.0 dCi
F 026 402 111	AUDI	Q5 (8RB,8R7) 2.0 TDI quattro
F 026 402 113	LAND ROVER GROUP	Discovery III 2.7 TDV6 AWD
F 026 402 114	JEEP	Cherokee 2.5 CRD 4x4
F 026 402 115	LEXUS	IS 220 d
F 026 402 119	LAND ROVER GROUP	Range Rover III 3.6 TDV8 AWD
F 026 402 120	CITROEN	C4 2.0 HDi
F 026 402 121	FORD	Transit FT 260 K/S 2.0 TDCi
F 026 402 122	FORD	Transit FT 260 K/S 2.0 TDCi
F 026 402 124	SMART (MCC)	Fortwo 0.8
F 026 402 125	NISSAN	Murano 2.5 dCi 4x4
F 026 402 126	NISSAN	Qashqai 1.5 dCi
F 026 402 127	PEUGEOT	J 5 1.9 D Turbo
F 026 402 143	MERCEDES-BENZ	Vario 613 D
F 026 402 808	AUDI	A6 Allroad (C7) 3.0 TDI
F 026 402 809	AUDI	Q3 2.0 TDI, TDI quattro
F 026 402 810	TOYOTA	Yaris 1.4 D-4D
F 026 402 811	TOYOTA	Land Cruiser 4.5 D-4D 4x4
F 026 402 812	VW (VOLKSWAGEN)	Jetta 1.6 TDI
F 026 403 005	OPEL	Corsa A 1.2
F 026 403 014	VOLVO	S60 1.6 T3, T4, T4F
F 026 403 019	TOYOTA	Hiace 2.7 , 4x4
F 026 403 020	MINI (BMW)	Mini Cooper
F 026 403 021	CHRYSLER	Voyager 2.0 i
F 026 403 754	BMW	Serie X1 (E84) X 1 20i sDrive
F 026 403 755	TOYOTA	Hilux 2.7 i, i 4WD
F 026 403 757	LEXUS	LX 470 4x4
F 026 403 758	CHRYSLER	Voyager 2.4



1 457 433 299	RENAULT	Trafic 2.1 D
1 457 433 336	VOLVO	S60 2.4 T, T AWD, T5
1 457 433 337	CITROEN	Berlingo 1.6
1 457 433 338	CHRYSLER	PT Cruiser 1.6
1 457 433 611	MAN	Bus 8t 8.220
F 026 400 128	HYUNDAI	i10 1.2
F 026 400 167	CHEVROLET	Matiz 0.8 i
F 026 400 168	HYUNDAI	Atos 1.1 i
F 026 400 169	KIA	Picanto 1.1 CRDI
F 026 400 170	TOYOTA	Prius 1.5 i
F 026 400 171	TOYOTA	Auris 1.4 D-4D
F 026 400 172	AUDI	A3 1.6 TDI
F 026 400 173	VW (VOLKSWAGEN)	Fox 1.4
F 026 400 174	CITROEN	C4 1.4
F 026 400 175	NISSAN	Primera 1.9 D Turbo
F 026 400 177	MINI (BMW)	Mini Cooper
F 026 400 180	AUDI	A3 3.2 quattro
F 026 400 182	AUDI	Q7 3.0 TDI
F 026 400 183	NISSAN	Cabstar 2.5 D Turbo
F 026 400 186	HYUNDAI	Galloper 2.5 D
F 026 400 187	HYUNDAI	CoupÃ© 1.6 i
F 026 400 191	SUZUKI	Liana 1.6 i 16V
F 026 400 192	LEXUS	GS 300
F 026 400 193	TOYOTA	Hilux 2.4 D
F 026 400 194	ALFA ROMEO	4C 1.8
F 026 400 196	VOLVO	FH 16
F 026 400 200	CITROEN	C-Crosser 2.0 , 4x4
F 026 400 202	FORD	Transit FT 300 2.4 TDCi
F 026 400 203	CHEVROLET	Captiva 2.0 CDRi, CDRi 4x4
F 026 400 204	SAAB (SAAB AUTOMOBILE AB)	9-5 1.9 TiD
F 026 400 206	SUBARU	Forester 2.0
F 026 400 214	MERCEDES-BENZ	Serie C (204) 200 CDI
F 026 400 217	CHEVROLET	Cruze 1.4 Turbo
F 026 400 218	LEXUS	ES 250 i
F 026 400 219	CITROEN	C4 1.6 THP
F 026 400 220	CITROEN	Berlingo 1.6 HDi
F 026 400 221	MITSUBISHI	L 200 2.5 DI-D
F 026 400 222	NISSAN	Micra 1.2 i
F 026 400 223	HONDA	City 1.4
F 026 400 224	HONDA	Insight 1.3 Hybrid
F 026 400 225	LEXUS	GX 470 4x4
F 026 400 226	TOYOTA	Land Cruiser 4.5 D-4D 4x4
F 026 400 227	DAIHATSU	Bego 1.5 i
F 026 400 228	HYUNDAI	Elantra 1.6
F 026 400 229	RENAULT	Megane III 2.0 dCi
F 026 400 230	NISSAN	NV400 2.3 dCi 100 FWD, dCi 100 RWD, dCi 125 FWD, dCi 125 RWD, dCi 150 FWD, dCi 150 RWD
F 026 400 231	SUZUKI	Alto 1.0
F 026 400 232	HONDA	Accord 2.2 CTDI

nl

Nieuwe opnamen

sv

Nya produkter

cs

Nové produkty

pl

Nowe produkty

ru

Новинки

F 026 400 234	RENAULT	Laguna III 2.0 dCi
F 026 400 236	BMW	Serie X3 (F25) X 3 35i xDrive
F 026 400 243	OPEL	Meriva 1.4 ecoFLEX, Ecotec
F 026 400 244	CHEVROLET	Malibu 2.0 CDRi
F 026 400 250	MERCEDES-BENZ	Citan 108 CDI
F 026 400 251	MG	MG TF 115 1.6i 16V
F 026 400 255	VOLVO	C30 2.0 D3, D4
F 026 400 258	ALFA ROMEO	MiTo 1.4
F 026 400 261	AUDI	A6 Allroad (C7) 3.0 TDI
F 026 400 263	MG	MGF 1.6 i 16V
F 026 400 264	VOLVO	S60 2.0 T
F 026 400 265	OPEL	Agila 1.3 CDTI
F 026 400 266	NISSAN	Interstar 3.0 D Turbo dCi 140
F 026 400 267	RENAULT	Laguna III 1.6
F 026 400 271	FORD	Fiesta V 2.0 i ST150
F 026 400 276	MITSUBISHI	Canter 2.8 D
F 026 400 283	AUDI	A4 Allroad (8KH) 2.0 TDI
F 026 400 285	SEAT	Mii 1.0
F 026 400 286	VW (VOLKSWAGEN)	Amarok 2.0 BiTDI, BiTDI 4Motion, TDI, TDI 4Motion
F 026 400 287	SKODA	Octavia 2.0 FSI RS
F 026 400 290	BMW	Serie 5 (F10;F11) Active Hybrid
F 026 400 291	KIA	Picanto 1.0 , Bi-Fuel
F 026 400 293	SUZUKI	Grand Vitara 2.7 i XL-7 4WD
F 026 400 294	SUZUKI	Escudo 2.4 i 4WD
F 026 400 295	HONDA	CR-V 2.0 i 4WD
F 026 400 296	LEXUS	LX 570 4x4
F 026 400 299	MINI (BMW)	Mini Cooper S
F 026 400 304	FIAT	Sedici 2.0 JTD, JTD 4x4
F 026 400 309	PEUGEOT	407 2.0 HDi, HDi 16V
F 026 400 312	MERCEDES-BENZ	Viano 3.0 CDI
F 026 400 320	PIAGGIO	Porter 1.3
F 026 400 322	NISSAN	Cabstar 3.0 D Turbo
F 026 400 323	RENAULT	Duster 1.5 dCi 4x4



F 026 407 108	ALFA ROMEO	Giuletta 2.0 JTDM
F 026 407 109	ALFA ROMEO	Brera 3.2 JTS 24V, JTS 24V Q4
F 026 407 112	DODGE	Caliber 2.2 CRD
F 026 407 116	AUDI	A1 1.2 TFSI
F 026 407 122	AUDI	A4 Allroad (8KH) 3.0 TDI
F 026 407 123	BMW	Serie X1 (E84) X 1 16 d sDrive
F 026 407 125	NISSAN	NV400 2.3 dCi 100 FWD, dCi 100 RWD, dCi 125 FWD, dCi 125 RWD, dCi 150 FWD, dCi 150 RWD
F 026 407 130	CHEVROLET	Aveo 1.2
F 026 407 143	AUDI	A1 1.4 TFSI
F 026 407 144	SEAT	Ibiza 1.2 TDI
F 026 407 147	HYUNDAI	Equus 3.8 GDI

de

Neuaufnahmen
(Fortsetzung)

en

New products
(continued)

fr

Nouveau enregistrements
(suite)

it

Nuovi insertimenti
(seguito)

es

Nuevas inclusiones
(continuación)



1 987 431 176	SSANGYONG	Rodius 2.7 Xdi, Xdi 4WD
1 987 432 004	CHEVROLET	Aveo 1.2
1 987 432 112	PEUGEOT	407 1.6 HDi
1 987 432 177	HONDA	Accord 2.4 i
1 987 432 246	NISSAN	Micra 1.2 DIG-S
1 987 432 247	NISSAN	Juke 1.5 dCi
1 987 432 250	SUBARU	Forester 2.0 i S Turbo 4x4
1 987 432 251	ALFA ROMEO	Giuletta 2.0 JTDM
1 987 432 253	HYUNDAI	ix20 1.4 , CRDi
1 987 432 254	KIA	Carnival 2.2 CRDi
1 987 432 255	HYUNDAI	Accent 1.3 i
1 987 432 257	NISSAN	Bluebird Sylphy 1.5 i
1 987 432 259	NISSAN	Maxima QX 2.0 i
1 987 432 260	KIA	Carens 1.6 i
1 987 432 262	SUBARU	Forester 2.0
1 987 432 263	LEXUS	GS 300 i
1 987 432 267	NISSAN	Cube 1.5 dCi
1 987 432 269	HYUNDAI	Grand Santa Fe 2.2 CRDi 4WD
1 987 432 272	SEAT	Mii 1.0
1 987 432 273	CHRYSLER	Sebring 2.0
1 987 432 274	FORD	Transit FT 250 2.2 TDCi
1 987 432 275	MAZDA	2 1.3
1 987 432 277	HYUNDAI	Tucson 2.0 CRDi, CRDi 4x4
1 987 432 278	HYUNDAI	Tucson 2.0 CRDi, CRDi 4x4
1 987 432 304	CHEVROLET	Aveo 1.2
1 987 432 392	MAZDA	2 1.25
1 987 432 542	BMW	Serie X3 (F25) X 3 20 d xDrive
1 987 432 545	RENAULT	Scenic III 1.2
1 987 432 548	AUDI	A6 Allroad (C7) 3.0 TDI
1 987 432 549	PEUGEOT	505 2.0 Blue HDI
1 987 432 566	CITROEN	C-Zero
1 987 432 568	JAGUAR	XF 2.0 EcoBoost
1 987 432 571	MERCEDES-BENZ	Serie SLK (170,171,172) 55 AMG
1 987 432 574	FORD	Transit FT 250 2.2 TDCi
1 987 432 598	FORD	C-MAX 1.0 EcoBoost

nl

Nieuwe opnamen
(vervolg)

sv

Nya produkter
(fortsättning)

cs

Nové produkty
(pokračování)

pl

Nowe produkty
(continuação)

ru

Новинки
(продолжение)



F 026 402 017	RENAULT	Kerax 380
F 026 402 036	IVECO	EuroCargo 75 E
F 026 402 100	SCANIA	G 340
F 026 402 107	SCANIA	G 230
F 026 402 118	VOLVO	B 12
F 026 402 134	MAN	E2000 Evol. (FE) 35.360
F 026 402 136	MAN	Bus 18t 18.260
F 026 402 138	MERCEDES-BENZ	Actros II 1832
F 026 402 140	MAN	Bus 8t 8.220



0 986 626 789	DAF	XF 95
0 986 626 791	SCANIA	Serie 144 R/ T
1 457 432 204	HAMM	DV 8
1 457 433 557	AHLMANN	AF 60
1 457 433 558	IRMER U. ELZE	Irmair 8
1 457 433 610	DAF	F.. 2700
1 457 433 671	VOLVO	F 10
1 457 433 726	RENAULT	C 230
1 457 433 731	RENAULT	Agora Citybus
F 026 400 073	IVECO	EuroCargo 100 E
F 026 400 076	IVECO	EuroMover 190 E/ 260 E
F 026 400 245	MERCEDES-BENZ	Unimog U 20
F 026 400 247	DAF	CF 85
F 026 400 249	MAN	TGA 28.310
F 026 400 252	NISSAN	Atleon 110/ 120
F 026 400 256	MAN	TGL 7.150
F 026 400 257	NEOPLAN	Trendliner N 3516
F 026 400 268	RENAULT	Midlum 150/ 180
F 026 400 275	RENAULT	Agora Line
F 026 400 277	RENAULT	Magnum 390
F 026 400 278	RENAULT	Ares 300/ 340
F 026 400 279	MAN	E2000 19.293
F 026 400 280	VOLVO	B 10
F 026 400 282	RENAULT	Midlum II 160
F 026 400 288	MERCEDES-BENZ	Atego 712
F 026 400 310	MERCEDES-BENZ	Citaro
F 026 400 314	MERCEDES-BENZ	Intouro
F 026 400 327	MAN	Lion's Regio
F 026 400 329	MERCEDES-BENZ	Citaro O 530
F 026 400 330	MERCEDES-BENZ	Touro OC 500



F 026 407 057	DAF	CF 65
F 026 407 118	VOLVO	B 12
F 026 407 119	DAF	CF 85



1 987 431 178	MERCEDES-BENZ	Unimog U 90/ U 100
1 987 431 181	MERCEDES-BENZ	Citaro O 530
1 987 431 187	MERCEDES-BENZ	Integro I O 550
1 987 431 189	MERCEDES-BENZ	Citaro O 530
1 987 431 191	SCANIA	Serie 94 P,R/ T
1 987 431 204	MAN	Bus 10t 10.150
1 987 431 206	MAN	FR / FRH 352
1 987 431 210	MERCEDES-BENZ	Cito O 520
1 987 431 229	VOLVO	B 7

de

DENOX-Filter von Bosch:
Weniger Emissionen,
weniger Verbrauch

en

Bosch DENOX-Filter:
Reduced emissions,
lower consumption

fr

Filtres DENOX de Bosch:
réduit les émissions,
baisse la consommation

it

Filtri DENOX di Bosch:
Meno emissioni,
meno consumi

es

Filtro DENOX de Bosch:
Menos emisiones,
menos consumo



DENOX 2.1

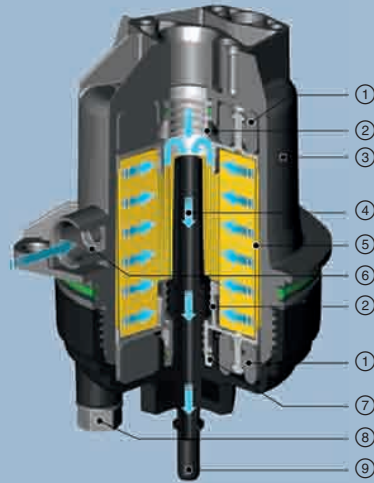

Alles spricht für DENOX-Filter von Bosch:

- ▶ langjährige Erfahrung mit AdBlue, der Filter passt perfekt zum Denoxtronic-System
- ▶ Hochwertige Materialien, die besonders resistent gegen das aggressive AdBlue sind – für sicheren Schutz des Denoxtronic-Systems
- ▶ regelmäßiger Filterwechsel gewährleistet die exakte Dosierung von AdBlue und damit die Einhaltung der EU-Abgasnormen

Strong arguments for Bosch DENOX filters:

- ▶ Years of experience with AdBlue; the filter is perfectly compatible with the Denoxtronic system
- ▶ High-quality materials offering exceptional resistance against the aggressive AdBlue – for a reliable protection of the Denoxtronic system
- ▶ regular filter replacement guarantees precise metering of AdBlue and thus compliance with EU emission standards

Des arguments forts pour les filtres DENOX de Bosch:

- ▶ une forte et longue expérience l'AdBlue, le filtre convient parfaitement au système Denoxtronic
- ▶ des matériaux de grande qualité résistant particulièrement bien à l'agressivité de la solution AdBlue assurent la protection fiable du système Denoxtronic
- ▶ le changement régulier du filtre garantit le dosage exact de la solution AdBlue et ainsi le respect des normes UE en matière de gaz d'échappement

Sono tanti i motivi per scegliere i filtri DENOX di Bosch:

- ▶ Esperienza pluriennale con AdBlue, il filtro si adatta perfettamente al sistema Denoxtronic
- ▶ Materiali di alta qualità, particolarmente resistenti all'aggressività dell'AdBlue - a garanzia di una protezione totale del sistema Denoxtronic
- ▶ La sostituzione ad intervalli regolari del filtro garantisce il dosaggio preciso di AdBlue e quindi il rispetto delle norme antinquinamento dell'UE

Argumentos a favor del filtro DENOX de Bosch:

- ▶ Muchos años de experiencia con AdBlue, el filtro es perfectamente adecuado para el sistema Denoxtronic
- ▶ Materiales de gran calidad especialmente resistentes al agresivo AdBlue – para una protección segura del sistema Denoxtronic
- ▶ Un cambio regular del filtro garantiza una dosificación exacta de AdBlue y, con ello, el respeto de las normas de gases de escape de la UE

Type/KIT									
DENOX 1 Service	F 00B H40 096	●	●	●	●	●			MAN
DENOX 1 Service	F 00B H40 230	●	●	●	●	●			DAF, IVECO, Scania, Volvo
DENOX 1 Repair	F 00B H40 025			●		●	●		DAF, MAN, IVECO, Scania, Volvo
DENOX 2.1 Service	1 457 436 006	●		●	●				Case, IVECO, KHD, Renault, Volvo
DENOX 2.1 Repair	1 457 030 020							●	Case, IVECO, KHD, Renault, Volvo
DENOX 2.2 Service	1 457 436 033	●	●					●	Cummins, Mack, Nissan, Renault, Volvo
DENOX 6.5 Service	1 457 436 039	●	●					●	Perkins, CNH, JCB, Daimler India, CAMC (China)

nl	sv	cs	pl	ru
DENOX-filter van Bosch: Minder uitstoot, minder verbruik	DENOX-filter från Bosch: Mindre emissioner, mindre förbrukning	DENOX-Filtr od fy Bosch: Méně emisí, nižší spotřeba	Filtry DENOX firmy Bosch: Mniej emisji, niższe zużycie paliwa	Фильтр DENOX производ- ства Bosch: Меньше вы- бросов, меньше расход

1 = Oberes/unteres
Ausgleichselement
2 = Endscheibe
3 = Gehäuse
4 = Gefiltertes AdBlue
5 = Filtermedium
6 = AdBlue Zuleitung
7 = O-Ring
8 = AdBlue Ablassschraube
9 = AdBlue Auslass

1 = Compensation supérieure/
inférieure
2 = Rondelle d'extrémité
3 = Boîtier
4 = AdBlue filtrée
5 = Matière filtrante
6 = Entrée AdBlue
7 = Joint torique
8 = Vis de vidange AdBlue
9 = Sortie AdBlue

1 = elemento de compensa-
ción superior/inferior
2 = disco final
3 = carcasa
4 = AdBlue filtrado
5 = medio filtrante
6 = tubería de alimentación
de AdBlue
7 = anillo toroidal
8 = tornillo de purga de AdBlue
9 = salida de AdBlue

1 = övre/undre
utjämningselement
2 = slutskiva
3 = hus
4 = filterrad AdBlue
5 = filtermedium
6 = AdBlue matarledning
7 = O-ring
8 = AdBlue avtappningskrur
9 = AdBlue utlopp

1 = Górný/dolný element
wyrównawczy
2 = Zašleпка
3 = Obudowa
4 = Przewod zasilający dodatek
AdBlue
5 = Medium filtrujące
6 = Przewód zasilający AdBlue
7 = Pierścień uszczelniający
8 = Śruba spustowa AdBlue
9 = Spust AdBlue

1 = Compensation element
2 = Lid
3 = Housing
4 = Filtered AdBlue
5 = Cellulose
6 = AdBlue Inlet
7 = O-ring
8 = AdBlue drain screw
9 = AdBlue outlet

1 = elementi di compensazione
superiore/inferiore
2 = rondella
3 = corpo
4 = AdBlue filtrato
5 = materiale filtrante
6 = ingresso AdBlue
7 = O-Ring
8 = vite di scarico AdBlue
9 = uscita AdBlue

1 = bovenste/onderste
compensatie-element
2 = eindschijf
3 = behuizing
4 = gefilterd AdBlue
5 = filtermedium
6 = AdBlue-toevoer
7 = O-ring
8 = AdBlue-aftapschroef
9 = AdBlue-afvoer

1 = Horní/dolní vyrovnávací
prvek
2 = Víko
3 = Pouzdro
4 = Filtrované AdBlue
5 = Filtrační médium
6 = Přívod AdBlue
7 = O-kroužek
8 = Výpustný šroub AdBlue
9 = Výpust AdBlue

1 = Верхний/нижний
компенсатор
2 = Концевая шайба
3 = Корпус
4 = Отфильтрованный AdBlue
5 = Фильтрующая среда
6 = Подводящая линия
AdBlue
7 = Кольцо круглого сечения
8 = Резьбовая пробка слив-
ного отверстия AdBlue
9 = Выпуск AdBlue

Alles pleit voor DENOX-filters van Bosch:

- ▶ langjarige ervaring met AdBlue, het filter past perfect bij het Denoxtronic-systeem
- ▶ Hoogwaardige materialen die bijzonder resistent tegen het agressieve AdBlue zijn – voor een veilige bescherming van het Denoxtronic-systeem
- ▶ regelmatige het filter vervangen garandeert de exacte dosering van AdBlue en daarmee naleving van de EU-uitlaatgasnormen

Allt talar för DENOX- filtret från Bosch:

- ▶ mångåriga erfarenheter med AdBlue, filtret passar perfekt till Denoxtronic-systemet
- ▶ Högvärdiga material, vilka är speciellt resistenta mot det aggressiva AdBlue – för säkert skydd av Denoxtronic-systemet
- ▶ regelmässigt filterbyte garanterar exakt dosering av AdBlue och därmed även att EU-avgasstandarderna uppfylls

Vše svědčí pro DENOX- Filtr od fy Bosch:

- ▶ mnohaleté zkušenosti s AdBlue, filtr se perfektně hodí k systému Denoxtronic
- ▶ vysoce kvalitní materiály, které jsou mimořádně odolné vůči agresivnímu AdBlue - pro bezpečnou ochranu systému Denoxtronic
- ▶ pravidelná výměna filtru zabezpečuje přesné dávkování AdBlue a tím také dodržení emisních EU norem

Wszystko przemawia za filtrami DENOX firmy Bosch:

- ▶ długoletnie doświadczenie w zakresie stosowania AdBlue, filtr pasuje doskonale do systemu Denoxtronic;
- ▶ wysokogatunkowe materiały, szczególnie odporne na agresywny chemicznie dodatek AdBlue, zapewniają właściwą ochronę systemu Denoxtronic;
- ▶ regularna wymiana filtra zapewnia dokładne dawkowanie dodatku AdBlue, a tym samym spełnienie europejskich norm czystości spalin.

Все говорит в пользу фильтра DENOX производства Bosch:

- ▶ многолетний опыт успешной эксплуатации с AdBlue; этот фильтр идеально подходит для системы Denoxtronic
- ▶ высококачественные материалы, обладающие повышенной стойкостью к агрессивной среде AdBlue, обеспечивают защиту системы Denoxtronic
- ▶ регулярная замена фильтра гарантирует точную дозировку AdBlue и соблюдение европейских норм токсичности ОГ

de	en	fr	it	es
Öl-Wechselfilter	Easy-change oil filters	Filtres à huile à rechange rapide	Filtro olio a cambio rapido	Filtros de aceite intercambiables

	Fig.	H mm	Ø mm	A	p ₁ bar	p ₂ bar
0 451 ...						
0 451 102 056	47	79	80	¾" 16 UNF	-	-
0 451 103 004	47	95	96	¾" 16 UNF	0,12	1,20
0 451 103 028	47	121	96	¾" 16 UNF	0,12	2,50
0 451 103 029	47	97	94	¾" 16 UNF	0,12	1,00
0 451 103 033	47	123	80	¾" 16 UNF	0,12	2,50
0 451 103 038	**	114	96	¾" 16 UNF	-	1,60
0 451 103 050	47	89	78	¾" 16 UNF	-	2,20
0 451 103 060	47	69	96	¾" 16 UNF	0,12	1,20
0 451 103 062	47	102	96	¾" 16 UNF	0,12	2,50
0 451 103 074	47	123	80	¾" 16 UNF	0,12	1,00
0 451 103 079	47	89	77	M 18 x 1,5	-	-
0 451 103 086	47	123	80	¾" 16 UNF	0,12	2,50
0 451 103 093	47	70	94	¾" 16 UNF	-	-
0 451 103 096	47	100	80	¾" 16 UNF	0,12	1,20
0 451 103 105	47	124	78	¾" 16 UNF	0,12	1,00
0 451 103 109	47	102	78	M 20 x 1,5	0,12	1,00
0 451 103 111	47	100	78	¾" 16 UNF	0,12	1,00
0 451 103 141	47	63	78	¾" 16 UNF	0,12	0,60
0 451 103 144	47	119	80	M 20 x 1,5	-	0,60
0 451 103 170	47	97	96	¾" 16 UNF	0,12	1,40
0 451 103 189	47	88	90	¾" 16 UNF	0,12	1,00
0 451 103 213	47	123	80	M 20 x 1,5	0,12	2,20
0 451 103 217	47	114	96	¾" 16 UNF	-	-
0 451 103 219	47	85	96	¾" 16 UNF	0,12	1,10
0 451 103 221		85	96	¾" 16 UNF	0,13	1,11
0 451 103 224	47	85	96	M 20 x 1,5	0,12	1,10
0 451 103 227	47	89	77	¾" 16 UNF	0,12	1,00
0 451 103 232	47	100	76	M 18 x 1,5	-	-
0 451 103 235	47	56	78	M 20 x 1,5	-	1,20
0 451 103 238	47	139	94	M 20 x 1,5	-	1,00
0 451 103 240	47	119	90	M 20 x 1,5	0,12	0,70
0 451 103 249	47	170	80	¾" 16 UNF	0,12	2,50
0 451 103 251	47	96	94	¾" 16 UNF	0,12	1,00
0 451 103 252	47	95	97	M 22 x 1,5	0,12	0,80
0 451 103 253	47	141	94	¾" 16 UNF	0,09	2,50
0 451 103 257	47	128	110	¾" 16 UNF	0,12	2,50
0 451 103 258	47	123	80	¾" 16 UNF	0,12	2,50
0 451 103 259	47	124	77	¾" 16 UNF	0,12	1,00
0 451 103 260	47	95	96	M 20 x 1,5	0,12	1,50
0 451 103 261	47	89	80	M 20 x 1,5	0,12	1,50
0 451 103 266	47	112	84	M 22 x 1,5	0,12	1,00
0 451 103 270	47	82	102	M 20 x 1,5	-	-
0 451 103 271	47	80	80	¾" 16 UNF	0,12	0,60

	Fig.	H mm	Ø mm	A	p ₁ bar	p ₂ bar
0 451 103 274	47	69	96	¾" 16 UNF	0,12	1,20
0 451 103 275	47	72	84	M 20 x 1,5	-	1,00
0 451 103 276	47	86	68	¾" 16 UNF	0,12	1,00
0 451 103 278	47	119	93	1" X 12 UNF-2B	-	1,00
0 451 103 280	47	136	80	¾" 16 UNF	0,12	2,50
0 451 103 289	47	102	96	¾" 16 UNF	0,12	2,50
0 451 103 290	47	120	90	¾" 16 UNF	0,12	2,50
0 451 103 292	47	75	68	M 20 x 1,5	0,12	1,50
0 451 103 297	47	79	80	M 18 x 1,5	-	1,00
0 451 103 298	47	79	80	¾" 16 UNF	0,12	1,00
0 451 103 299	47	89	80	M 20 x 1,5	0,12	0,80
0 451 103 300	47	67	77	M 20 x 1,5	-	1,00
0 451 103 311	47	76	96	1 ³ / ₁₆ " 16 UN	-	1,20
0 451 103 313	47	114	96	¾" 16 UNF	0,12	3,00
0 451 103 314	47	123	80	¾" 16 UNF	0,12	2,50
0 451 103 316	47	72	84	M 20 x 1,5	0,12	1,00
0 451 103 318	47	92	80	¾" 16 UNF	0,12	2,50
0 451 103 330	47	114	93	M 23 x 1,5	0,12	1,60
0 451 103 333	47	97	94	M 22 x 1,5	0,12	1,20
0 451 103 335	47	119	80	1" 12 UNF	0,12	1,00
0 451 103 336	47	53	78	M 20 x 1,5	0,12	1,30
0 451 103 337	47	93	80	¾" 16 UNF	0,12	1,00
0 451 103 338	47	203	80	M 24 x 2	0,12	2,50
0 451 103 340	47	124	78	1 ³ / ₁₆ " 16 UN	-	1,00
0 451 103 341	47	76	93	1 ³ / ₁₆ " 16 UN	-	1,00
0 451 103 342	47	100	80	¾" 16 UNF	0,12	0,80
0 451 103 343	47	260	113	1 ⁷ / ₈ " 16 UNF	-	-
0 451 103 344	47	120	78	¾" 16 UNF	0,09	2,50
0 451 103 346	47	140	94	¾" 16 UNF	0,12	2,20
0 451 103 347	47	140	90	¾" 16 UNF	0,12	2,50
0 451 103 348	47	190	80	M 24 x 2	0,12	2,50
0 451 103 349	47	79	80	¾" 16 UNF	0,12	1,50
0 451 103 350	47	100	80	¾" 16 UNF	0,12	1,50
0 451 103 351	47	79	80	¾" 16 UNF	0,12	1,50
0 451 103 352	47	100	80	¾" 16 UNF	0,12	1,50
0 451 103 353	47	89	90	M 20 x 1,5	0,12	1,20
0 451 103 354	47	79	80	M 20 x 1,5	0,12	1,20
0 451 103 355	47	89	80	M 20 x 1,5	0,12	1,50
0 451 103 357	47	122	94	¾" 16 UNF	-	-
0 451 103 363	47	93	79	¾"-16 UNF 2B	-	1,00
0 451 103 365	47	98	103	M 24 x 1,5	-	1,00
0 451 103 366	47	117	95	M 26 x 1,5	0,12	1,00
0 451 103 367	47	100	76	1" 12 UNF-1B	0,12	1,00
0 451 103 368	**	91	140	1 ¹ / ₂ " 16 UN	0,12	1,40
0 451 103 369	47	120	78	¾" 16 UNF	0,12	1,60

nl

Oliefilters box

sv

Oljefilter

cs

Olejový filtr

pl

Wymienne filtry oleju

ru

Сменный масляный
фильтр

	Fig.	H mm	Ø mm	A	p_{1-} bar	p_{2-} bar
0 451 103 370	47	79	78	M 18 x 1,5	-	-
0 451 103 371	47	120	79	¾" 16 UNF	0,12	1,20
0 451 103 372	47	85	71	M 20 x 1,5	0,12	1,00
0 451 104 005	47	140	94	1 ³ / ₁₆ " 16 UNF	1,00	1,60
0 451 104 010	**	260	110	1 ¹ / ₈ " 16 UN	-	-
0 451 104 013	47	302	140	M 42 x 1,5	-	2,50
0 451 104 014	47	114	96	¾" 16 UNF	0,12	1,00
0 451 104 015	47	210	93	1"-12 UNF	0,12	2,50
0 451 104 025	47	60	68	M 20 x 1,5	-	1,30
0 451 104 026	47	89	78	1 ³ / ₁₆ " 16 UN	-	1,00
0 451 104 063	47	142	96	¾" 16 UNF	0,12	1,20
0 451 104 065	47	140	94	¾" 16 UNF	0,12	2,20
0 451 104 066	47	142	96	1" 12 UNF	0,12	2,50
0 451 104 067	47	86	67	¾" 16 UNF	-	1,20
0 451 105 067	47	210	94	1" 12 UNF	0,12	2,50
0 451 105 188	47	217	96	1" 12 UNF	0,12	2,50
0 451 203 002	47	177	94	1" x 12 UNF-2B	0,12	1,60
0 451 203 010	47	170	96	¾" 16 UNF	0,12	0,70
0 451 203 012	47	151	96	¾" 16 UNF	0,12	2,50
0 451 203 087	47	183	96	¾" 16 UNF	0,12	2,50
0 451 203 108	47	114	96	M 20 x 1,5	0,12	0,90
0 451 203 152	47	127	102	¾" 16 UNF	0,12	1,60
0 451 203 154	47	95	96	¾" 16 UNF	0,12	0,80
0 451 203 194	47	139	93	¾" 16 UNF	0,12	1,00
0 451 203 201	47	145	110	¾" 16 UNF	0,12	2,50
0 451 203 218	47	141	96	1" 12 UNF	2,50	x
0 451 203 220	47	177	95	1" x 12 UNF-2B	0,12	2,20
0 451 203 223	47	122	110	¾" 16 UNF	0,12	2,50
0 451 203 227	1	170	96	1" 12 UNF	0,12	1,60
0 451 203 228	**	177	93	1" x 16 UN-2B	-	-

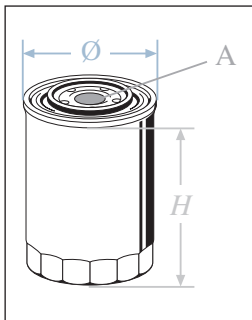

- x Rücklaufsperr/Umgehungsventil eingebaut, jedoch Druck nicht bekannt.
Integrated check valve/bypass valve, but pressure not defined.
Clapet anti-retour intégré/soupape de dérivation, mais seuil de pression inconnu.
Valvola antiritorno incorporata/valvola di bypass, pressione non nota.
Bloqueo de retorno incorporado/valvula de derivación, pero presión desconocida.
Terugstroomblokkering ingebouwd/bypas klep, maar druk niet bekend.
Inbyggd returspär/föribilendigsventil, men trycket obekant.
Zpětný ventil je vestavěn/obtok. ventilu, tlak však není definován.
Zamontowany zawór jednokierunkowy/zaworu obejściowego, ale nie określono ciśnienia.
Блокировка обратного потока установлена/перепускного клапана, но давление неизвестно.

* Neu / New / Nouveau / Nuovo / Nuevo / Nieuwe / Ny / Nové / Nowe / Новые

** siehe Online-Katalog / see online catalog / voir le catalogue en ligne / vedi catalogo online / Ver catálogo online / zie online catalogus / se onlinekatalog / viz katalog online / zobacz katalog online / см. онлайн-каталог

	Fig.	H mm	Ø mm	A	p_{1-} bar	p_{2-} bar
0 451 300 003	47	260	110	1 ³ / ₈ " 16 UN	-	-
0 451 301 156	47	227	110	1" 12 UNF	0,12	1,20
0 451 301 207	47	178	110	M 30 x 2	-	2,50
0 451 302 182	**	182	102	¾" 16 UNF	-	1,60
0 451 403 001	47	273	110	1 ¹ / ₈ " 16 UNF	0,12	2,50
0 451 403 077	47	260	110	1 ¹ / ₈ " 16 UNF	-	-
0 451 403 208	47	302	140	1 ¹ / ₂ " 16 UN	-	2,50
0 451 403 210	47	302	139	1 ¹ / ₂ " 16 UN	-	2,50
0 986 ...						
0 986 452 000	47	119	85	¾" 16 UNF	0,12	-
0 986 452 001	47	140	95	¾" 16 UNF	-	1,00
0 986 452 003	47	97	95	¾" 16 UNF	0,12	1,00
0 986 452 005	47	121	94	¾" 16 UNF	-	-
0 986 452 016	47	74	84	M 20 x 1,5	0,12	1,00
0 986 452 019	47	72	84	¾" 16 UNF	0,12	1,00
0 986 452 020	47	120	86	M 20 x 1,5	0,12	1,00
0 986 452 023	47	100	84	¾" 16 UNF	-	1,00
0 986 452 024	47	98	95	¾" 16 UNF	-	1,00
0 986 452 028	47	72	68	¾" 16 UNF	-	1,00
0 986 452 030	47	82	103	M 24 x 1,5	0,12	1,00
0 986 452 035	47	72	84	¾" 16 UNF	0,12	-
0 986 452 036	47	92	84	M 20 x 1,5	0,12	1,00
0 986 452 041	47	87	70	M 20 x 1,5	0,12	1,00
0 986 452 042	47	126	103	M 26 x 1,5	0,12	1,00
0 986 452 044	47	89	77	¾" 16 UNF	0,12	1,00
0 986 452 046	47	139	96	1" x 12 UNF-2B	0,12	-
0 986 452 058	47	67	70	¾" 16 UNF	0,12	1,00

de
Öl-Wechselfilter
 (Fortsetzung)

en
Easy-change oil filters
 (continued)

fr
Filtres à huile à rechange rapide
 (suite)

it
Filtro olio a cambio rapido
 (seguito)

es
Filtros de aceite intercambiables
 (continuación)

nl
Oliefilters box
 (vervolg)

sv
Oljefilter
 (fortsättning)

cs
Oleřový filtr
 (pokračování)

pl
Wymienne filtry oleju
 (ciąg dalszy)

ru
Сменный масляный фильтр
 (продолжение)

		Fig.	H mm	Ø mm	A	p ₁ bar	p ₂ bar
0 986 452 060		47	87	68	¾" 16 UNF	0,12	–
0 986 452 061		47	67	70	M 20 x 1,5	0,12	1,50
0 986 452 062		47	125	103	M 24 x 1,5	–	1,00
0 986 452 063		47	150	103	M 26 x 1,56 H	–	1,00
0 986 452 064		47	121	94	M 26 x 1,56 H	0,12	1,00
0 986 452 066		47	126	103	M 20 x 1,5	0,12	1,00
0 986 452 400		47	142	96	¾" 16 UNF	0,12	2,50
0 986 B00 006		**	95	93	M 20 x 1,5	0,12	0,40

F 026 ...							
		Fig.	H mm	Ø mm	A	p ₁ bar	p ₂ bar
F 026 407 001		47	71	69	M 20 x 1,5	–	1,00
F 026 407 004		**	149	93	¾" 16 UNF	0,09	2,50
F 026 407 005		**	80	80	¾" 16 UNF	0,12	0,80
F 026 407 017		47	92	78	M 20 x 1,5	–	1,20
F 026 407 018		47	117	89	¾" 16 UNF	0,09	1,20
F 026 407 022		47	63	78	M 20 x 1,5	–	2,50
F 026 407 024		47	77	97	M 22 x 1,5	–	2,50
F 026 407 025		47	86	70	M 20 x 1,5	–	1,20
F 026 407 027		47	102	78	M 20 x 1,5	–	1,20
F 026 407 043		47	260	108	1½-16 UN-2B	–	–
F 026 407 044		47	81	77	¾" 16 UNF	–	2,50
F 026 407 048		47	228	113	M 30 x 2	–	–
F 026 407 049		47	213	110	M 30 x 2	0,12	2,50
F 026 407 053		47	142	93	M 22 x 1,5 6H	0,12	1,70
F 026 407 057*		47	171	96	M27 x 2	–	–
F 026 407 058¹⁾		**	124	97	–	–	–
F 026 407 059¹⁾		**	116	93	–	–	–
F 026 407 077		47	90	68	M 20 x 1,5	0,12	1,00

		Fig.	H mm	Ø mm	A	p ₁ bar	p ₂ bar
F 026 407 078		47	76	78	¾" 16 UNF	0,12	1,00
F 026 407 079		47	80	78	¾" 16 UNF	0,12	2,00
F 026 407 080		75	142	78	M 27 x 1,5	0,12	2,50
F 026 407 083		47	142	96	M 22 x 1,5	0,12	2,50
F 026 407 089		47	50	69	M 20 x 1,5	0,12	1,00
F 026 407 099¹⁾		**	68	82	–	–	–
F 026 407 101		**	177	96	M 27 x 2	–	–
F 026 407 104		**	101	78	M 20 x 1,5	0,12	1,60
F 026 407 105		47	260	110	M 30 x 2	0,12	2,50
F 026 407 106		47	98	98	¾" 16 sp-6H	–	1,35
F 026 407 116*		**	97	78	¾" 16 UNF	0,12	2,00
F 026 407 130*		**	73	67	M 18 x 1,5	–	1,35
F 026 407 143*		**	79,4	78	¾-16 UNF-1B	0,12	2,50

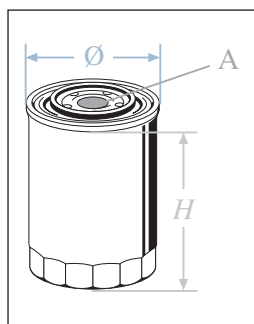

- x Rücklaufsperr/Umgehungsventil eingebaut, jedoch Druck nicht bekannt.
 Integrated check valve/bypass valve, but pressure not defined.
- Clapet anti-retour intégré/soupape de dérivation, mais seuil de pression inconnu.
- Valvola antiritorno incorporata/valvola di bypass, pressione non nota.
- Bloqueo de retorno incorporado/valvula de derivación, pero presión desconocida.
- Terugstroomblokkering ingebouwd/bypassklep, maar druk niet bekend.
- Inbyggd returspärr/förbilendigsventil, men trycket obekant.
- Zpětný ventil je vestavěn/obtok. ventilu, tlak však není definován.
- Zamontowany zawór jednokierunkowy/zaworu obejściowego, ale nie określono ciśnienia.
- Блокировка обратного потока установлена/перепускного клапана, но давление неизвестно.

* Neu / New / Nouveau / Nuovo / Nuevo / Nieuwe / Ny / Nové / Nowe / Новые

** siehe Online-Katalog / see online catalog / voir le catalogue en ligne / vedi catalogo online / Ver catálogo online / zie online catalogus / se onlinekatalog / viz katalog online / zobacz katalog online / см. онлайн-каталог

¹⁾ Öl-Zentrifuge (Rotor) / Oil centrifuge (rotor) / Centrifugeuse à huile (rotor) / Centrifuga olio (rotore) / Centrifugadora de aceite (rotor) / oliecentrifuge (rotor) / oljecentrifug (rotor) / Oleřová odstředivka (rotor) / wirówka do oleju (wirnik) / масляная центрифуга (ротор)

de

Ölfiltereinsätze

en

Oil-filter elements

fr

Cartouches de filtres
à huile

it

Cartucce filtranti
per filtri olio

es

Cartuchos filtrantes
para filtros de aceite

nl

Oliefilterpatronen

sv

Oljefilterinsatser

cs

Vložky olejového filtru

pl

Wkłady filtra oleju

ru

Элементы масляного
фильтра

	Fig.	H mm	Ø mm
0 451 ...			
0 451 104 010	47	260	110
0 986 ...			
0 986 452 036	**	92	84
0 986 452 041	**	87	70
0 986 452 058	**	67	70
1 457 ...			
1 457 429 103	49	107	84
1 457 429 105	49	101	59
1 457 429 107	48	195	83
1 457 429 108	48	102	65
1 457 429 113	**	117	70
1 457 429 117	49	117	73
1 457 429 118	48	79	68
1 457 429 119	49	115	64
1 457 429 121	49	164	83
1 457 429 122	48	159	62
1 457 429 123	49	158	89
1 457 429 126	49	135	64
1 457 429 127	48	55	53
1 457 429 128	48	314	121
1 457 429 130	49	196	117
1 457 429 137	49	147	114
1 457 429 139	48	159	83
1 457 429 141	48	160	80
1 457 429 142	48	110	83
1 457 429 144	48	113	61
1 457 429 147	48	78	53
1 457 429 152	48	195	70
1 457 429 153	49	212	62
1 457 429 154	49	99	70
1 457 429 165	49	120	81
1 457 429 167	56	86	118
1 457 429 174	50	107	84
1 457 429 175	49	125	110
1 457 429 178	49	78	61
1 457 429 184	49	87	53
1 457 429 185	49	155	64
1 457 429 192	**	141	71
1 457 429 193	**	141	59

	Fig.	H mm	Ø mm
1 457 429 194	56	62	64
1 457 429 196	49	115	63
1 457 429 197	49	82	72
1 457 429 198	49	86	92
1 457 429 199	48	92	72
1 457 429 238	48	99	72
1 457 429 239	75	53	91
1 457 429 243	48	125	64
1 457 429 244	48	125	64
1 457 429 248	48	74	64
1 457 429 249	48	69	64
1 457 429 252	48	153	64
1 457 429 256	65	83	65
1 457 429 257	48	72	62
1 457 429 261	48	154	47
1 457 429 262	48	79	72
1 457 429 263	48	115	64
1 457 429 264	49	110	82
1 457 429 265	52	196	92
1 457 429 267	52	196	92
1 457 429 268	48	155	64
1 457 429 269	48	79	74
1 457 429 270	6	202	110
1 457 429 271	48	101	73
1 457 429 272	48	116	53
1 457 429 274	52	169	92
1 457 429 275	49	123	82
1 457 429 276	49	133	78
1 457 429 277	50	195	78
1 457 429 278	49	169	83
1 457 429 284	48	75	73
1 457 429 286	2	142	117
1 457 429 301	48	76	65
1 457 429 302	48	124	91
1 457 429 306	48	90	57
1 457 429 307	**	151	89
1 457 429 308	**	85	65
1 457 429 416	49	26	81
1 457 429 493	49	141	69
1 457 429 546	49	-	-
1 457 429 559	49	117	98
1 457 429 600	49	243	100
1 457 429 605	50	106	59
1 457 429 610	50	121	83
1 457 429 616	50	154	71

	Fig.	H mm	Ø mm
1 457 429 619	48	153	62
1 457 429 629	49	196	117
1 457 429 631	53	211	128
1 457 429 636	56	183	91
1 457 429 638	49	110	81
1 457 429 646	49	195	78
1 457 429 647	49	133	78
1 457 429 648	49	151	121
1 457 429 649	49	120	59
1 457 429 732	49	195	78
1 457 429 735	49	171	120
1 457 429 740	49	249	120
1 457 429 755	49	129	81
1 457 429 760	49	89	81
1 457 429 762	49	79	76
1 457 429 820	49	101	60
1 457 437 001	**	115	64
1 457 437 002	**	115	64
1 457 437 003	**	104	83
F 026 ...			
F 026 404 004	48	149	64
F 026 407 002	**	200	76
F 026 407 003	48	150	83
F 026 407 006	**	103	57
F 026 407 007	**	144	73
F 026 407 008	65	95	71
F 026 407 010	**	102	69
F 026 407 011	**	129	69
F 026 407 014	654	113	58
F 026 407 015	**	87	62
F 026 407 016	**	89	61
F 026 407 021	48	155	64
F 026 407 023	66	101	65

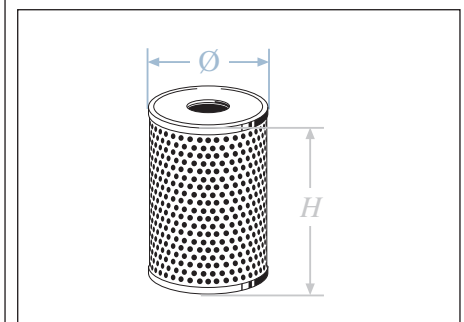

* Neu / New / Nouveau / Nuovo / Nuevo / Nieuwe / Ny / Nové / Nowe / Новые

** siehe Online-Katalog / see online catalog / voir le catalogue en ligne / vedi catalogo online / Ver catálogo online / zie online catalogus / se onlinekatalog / viz katalog online / zobacz katalog online / см. онлайн-каталог

de

Ölfiltereinsätze
(Fortsetzung)

en

Oil-filter elements
(continued)

fr

**Cartouches de filtres
à huile**
(suite)

it

**Cartucce filtranti
per filtri olio**
(seguito)

es

**Cartuchos filtrantes
para filtros de aceite**
(continuación)

nl

Oliefilterpatronen
(vervolg)

sv

Oljefilterinsatser
(fortsättning)

cs

Vložky olejového filtru
(pokračování)

pl

Wkłady filtra oleju
(ciąg dalszy)

ru

**Элементы масляного
фильтра** (продолжение)

	Fig.	H mm	Ø mm
---	------	---------	---------

F 026 407 026	**	211	82
F 026 407 040	**	152	83
F 026 407 042	**	264	113
F 026 407 045	48	220	113
F 026 407 046	75	150	113

F 026 407 047	48	220	113
F 026 407 051	**	204	121
F 026 407 054	**	378	200
F 026 407 060	**	124	97
F 026 407 061	65	110	72

F 026 407 062	65	120	61
F 026 407 066	**	200	76
F 026 407 067	75	101	67
F 026 407 068	65	94	64
F 026 407 069	**	118	62

F 026 407 070	65	115	64
F 026 407 071	**	83	67
F 026 407 072	**	172	64
F 026 407 073	65	93	73
F 026 407 075	65	110	84

F 026 407 076	75	108	83
F 026 407 077	**	90	68
F 026 407 090	65	82	71
F 026 407 091	65	57	62
F 026 407 092	**	56	61

F 026 407 093	**	67	70
F 026 407 094	**	156	71
F 026 407 095	**	105	66
F 026 407 096	**	105	66
F 026 407 097	75	125	63

F 026 407 098	**	67	69
F 026 407 100	48	281	90
F 026 407 102	75	109	84
F 026 407 108 *	**	100	72
F 026 407 109 *	**	96	53

F 026 407 112 *	**	110	63
F 026 407 118 *	**	105	70
F 026 407 119 *	**	147	103
F 026 407 122 *	**	127	76
F 026 407 123 *	**	133	53

F 026 407 125 *	**	112	57
F 026 407 144 *	**	–	–
F 026 407 147 *	**	104,5	65
F 026 407 075 *	65	105	83
F 026 407 076 *	75	108	83

	Fig.	H mm	Ø mm
---	------	---------	---------

F 026 407 087	**	105	66
F 026 407 090 *	65	82	70
F 026 407 091 *	65	57	61
F 026 407 097 *	75	125	63
F 026 407 100 *	48	281	90

F 026 407 102 *	75	108	83
------------------------	----	-----	----

	Fig.	H mm	Ø mm
---	------	---------	---------

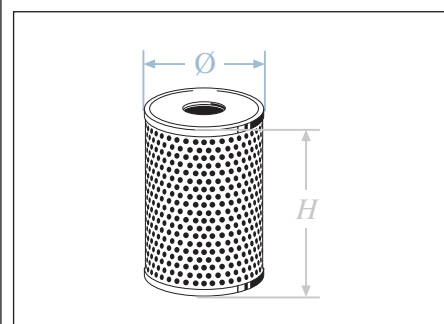

* Neu / New / Nouveau / Nuovo / Nuevo / Nieuwe / Ny / Nové / Nowe / Новые

** siehe Online-Katalog / see online catalog / voir le catalogue en ligne / vedi catalogo online / Ver catálogo online / zie online catalogus / se onlinekatalog / viz katalog online / zobacz katalog online / см. онлайн-каталог

de

Luftfiltereinsätze

en

Air-filter elements

fr

Cartouches de filtres
à air

it

Cartucce filtranti
per filtri aria

es

Cartuchos filtrantes
para filtros de aire

nl

Luchtfilterpatronen

sv

Luftfilterinsatser

cs

Vložky vzduchového filtru

pl

Wkłady filtra powietrza

ru

Элементы воздушного
фильтра

	Fig.	$a \times b \times c$ $H \times \varnothing$ mm
---	------	---

0 986 ...		
0 986 626 789*	**	485x303
0 986 626 791*	**	545x310

1 457 ...		
1 457 429 030	54	200x94x50
1 457 429 050	59	47x243
1 457 429 053	59	53x272

1 457 429 054	59	62x279
1 457 429 061	54	213x213x58
1 457 429 064	59	58x257
1 457 429 066	59	62x302
1 457 429 076	54	334x134x41

1 457 429 078	54	254x214x42
1 457 429 079	54	381x115x58
1 457 429 080	59	87x300
1 457 429 085	54	335x165x38
1 457 429 775	59	48x291

1 457 429 777	54	308x184x57
1 457 429 778	54	315x150x57
1 457 429 781	54	323x289x51
1 457 429 782	54	333x107x37
1 457 429 783	54	379x171x59

1 457 429 785	54	381x150x50
1 457 429 786	72	312x150x57
1 457 429 787	59	56x408
1 457 429 789	59	49x245
1 457 429 791	54	257x184x57

1 457 429 792	54	308x184x69
1 457 429 793	54	575x166x41
1 457 429 794	57	392x200
1 457 429 795	56	237x165
1 457 429 800	59	61x261

	Fig.	$a \times b \times c$ $H \times \varnothing$ mm
---	------	---

1 457 429 801	59	50x234
1 457 429 806	59	56x281
1 457 429 810	59	51x260
1 457 429 814	54	325x150x57
1 457 429 817	56	211x165

1 457 429 818	59	53x257
1 457 429 819	59	52x293
1 457 429 839	56	200x118
1 457 429 840	56	164x154
1 457 429 841	56	130x176

1 457 429 842	54	198x150x49
1 457 429 845	59	95x244
1 457 429 846	54	260x143x50
1 457 429 854	56	255x198
1 457 429 869	54	381x150x58

1 457 429 870	54	254x213x58
1 457 429 871	59	52x331
1 457 429 873	54	254x214x42
1 457 429 874	58	476x302
1 457 429 875	54	288x171x58

1 457 429 876	59	53x273
1 457 429 877	54	254x213x58
1 457 429 882	56	70x98
1 457 429 890	59	103x182
1 457 429 893	59	62x287

1 457 429 894	54	285x166x34
1 457 429 895	54	285x184x41
1 457 429 896	54	286x184x41
1 457 429 898	54	285x184x41
1 457 429 899	56	476x303

1 457 429 900	56	150x150
1 457 429 908	64	200x170
1 457 429 920	59	50x231
1 457 429 923	59	63x264
1 457 429 928	54	326x183x39

	Fig.	$a \times b \times c$ $H \times \varnothing$ mm
---	------	---

1 457 429 932	56	295x127
1 457 429 933	57	290x134
1 457 429 934	**	29x348
1 457 429 941	56	337x150
1 457 429 942	54	210x165

1 457 429 944	56	238x165
1 457 429 946	56	350x165
1 457 429 948	59	64x408
1 457 429 949	60	282x192x131
1 457 429 950	56	378x198

1 457 429 953	59	49x240
1 457 429 954	59	52x282
1 457 429 957	54	273x134x42
1 457 429 959	59	49x241
1 457 429 964	54	256x150x58

1 457 429 966	56	382x227
1 457 429 969	56	476x303
1 457 429 970	59	84x408
1 457 429 975	56	498x243
1 457 429 979	58	287x213

1 457 429 980	58	222x210
1 457 429 983	54	355x245x50
1 457 429 987	54	289x214x46
1 457 429 988	54	472x158x61
1 457 429 991	58	259x383

1 457 429 992	59	60x363
1 457 429 993	59	80x389
1 457 429 994	54	337x134x57
1 457 429 998	**	356x387
1 457 432 100	59	80x202

1 457 432 106	56	175x127
1 457 432 108	59	62x233
1 457 432 109	59	50x205
1 457 432 111	59	58x235
1 457 432 124	56	219x127

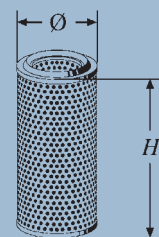
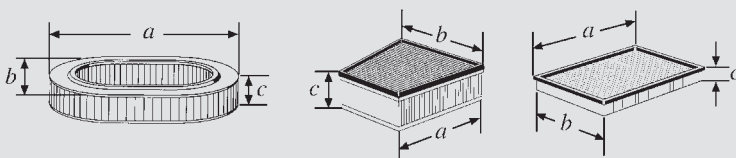

* Neu / New / Nouveau / Nuovo / Nuevo / Nieuwe / Ny / Nové / Nowe / Новые

** siehe Online-Katalog / see online catalog / voir le catalogue en ligne / vedi catalogo online / Ver catálogo online / zie online catalogus / se onlinekatalog / viz katalog online / zobacz katalog online / см. онлайн-каталог

de

Luftfiltereinsätze
(Fortsetzung)

en

Air-filter elements
(continued)

fr

Cartouches de filtres
à air
(suite)

it

Cartucce filtranti
per filtri aria
(seguito)

es

Cartuchos filtrantes
para filtros de aire
(continuación)

	Fig.	a x b x c	
		H x Ø mm	
1 457 432 128	59	52x218	
1 457 432 134	59	63x248	
1 457 432 138	56	178x160	
1 457 432 146	54	225x135x36	
1 457 432 149	56	157x132	
1 457 432 150	54	302x171x35	
1 457 432 154	56	124x168	
1 457 432 172	54	300x198x49	
1 457 432 173	54	177x90x49	
1 457 432 174	54	302x170x36	
1 457 432 178	54	248x169x38	
1 457 432 180	54	235x86x48	
1 457 432 183	54	242x131x59	
1 457 432 185	54	350x148x37	
1 457 432 188	56	381x303	
1 457 432 192	58	230x332	
1 457 432 200	54	325x156x57	
1 457 432 202	54	336x230x27	
1 457 432 203	54	333x241x57	
1 457 432 204*	59	91x317	
1 457 432 208	54	212x171x57	
1 457 433 002	54	221x228x58	
1 457 433 003	54	246x213x42	
1 457 433 004	54	243x178x58	
1 457 433 005	58	309x186	
1 457 433 006	60	378x278x62	
1 457 433 007	54	308x230x27	
1 457 433 008	54	275x185x57	
1 457 433 023	54	268x228x58	
1 457 433 032	59	110x215	
1 457 433 036	54	281x160x47	
1 457 433 037	54	256x210x43	
1 457 433 042	56	465x310	
1 457 433 043	54	520x86x58	
1 457 433 044	56	135x91	
1 457 433 045	54	239x188x58	
1 457 433 046	54	267x213x70	
1 457 433 047	54	340x143x50	
1 457 433 049	54	272x118x50	
1 457 433 052	54	363x142x58	
1 457 433 053	54	260x233x38	
1 457 433 054	54	211x166x37	
1 457 433 055	54	293x206x42	
1 457 433 056	54	234x177x41	
1 457 433 058	54	370x135x58	

	Fig.	a x b x c	
		H x Ø mm	
1 457 433 059	54	288x188x42	
1 457 433 060	54	312x150x70	
1 457 433 061	612	272x202x58	
1 457 433 062	57	219x129	
1 457 433 065	87	378x156x58	
1 457 433 066	54	287x167x36	
1 457 433 067	54	286x150x58	
1 457 433 069	62	332x106	
1 457 433 070	54	282x180x57	
1 457 433 071	54	354x134x48	
1 457 433 072	54	259x164x38	
1 457 433 073	54	260x180x40	
1 457 433 075	54	231x193x58	
1 457 433 076	78	382x140x49	
1 457 433 077	56	214x114	
1 457 433 078	54	186x78x58	
1 457 433 079	54	298x223x42	
1 457 433 080	54	258x143x58	
1 457 433 081	54	364x184x55	
1 457 433 083	54	268x168x34	
1 457 433 084	66	135x106	
1 457 433 085	54	245x178x57	
1 457 433 086	54	298x165x53	
1 457 433 087	54	285x184x40	
1 457 433 088	54	320x138x42	
1 457 433 089	54	306x212x45	
1 457 433 090	54	246x168x50	
1 457 433 091	54	295x182x62	
1 457 433 093	67	85x171	
1 457 433 094	61	294x231x47	
1 457 433 095	54	179x254x58	
1 457 433 096	54	172x280x52	
1 457 433 097	54	255x125x46	
1 457 433 098	54	170x243x69	
1 457 433 099	54	173x266x52	
1 457 433 100	63	165x215x47	
1 457 433 101	68	273x313x42	
1 457 433 102	69	405x173x37	
1 457 433 150	54	244x169x68	
1 457 433 152	54	271x261x55	
1 457 433 153	54	245x156x45	
1 457 433 154	56	231x136	
1 457 433 155	54	280x266x49	
1 457 433 156	54	306x135x63	
1 457 433 158	54	336x102x41	

	Fig.	a x b x c	
		H x Ø mm	
1 457 433 159	54	336x102x70	
1 457 433 160	54	318x114x58	
1 457 433 161	56	207x130	
1 457 433 163	54	377x83x57	
1 457 433 164	70	273x313x47	
1 457 433 200	57	261x131	
1 457 433 201	57	391x160	
1 457 433 204	**	351x198	
1 457 433 227	56	164x140	
1 457 433 228	71	185x130	
1 457 433 229	56	243x114	
1 457 433 230	56	255x127	
1 457 433 231	56	311x128	
1 457 433 232	56	75x360	
1 457 433 233	56	177x160	
1 457 433 234	56	210x138	
1 457 433 250	54	341x177x51	
1 457 433 251	54	342x230x24	
1 457 433 252	54	356x189x49	
1 457 433 253	54	247x180x39	
1 457 433 255	54	230x90x48	
1 457 433 256	54	258x105x60	
1 457 433 257	54	379x141x42	
1 457 433 258	56	250x149	
1 457 433 259	54	298x158x37	
1 457 433 260	54	323x100x57	
1 457 433 261	54	211x184x57	
1 457 433 263	54	282x159x58	
1 457 433 264	54	275x185x57	
1 457 433 265	54	246x169x57	
1 457 433 266	54	265x154x58	
1 457 433 268	54	287x157x47	
1 457 433 269	54	247x153x36	
1 457 433 272	54	345x170x39	
1 457 433 273	54	157x171x33	
1 457 433 274	54	227x170x35	
1 457 433 275	56	176x134	
1 457 433 276	54	343x170x46	
1 457 433 279	54	229x140x40	
1 457 433 280	54	210x169x57	
1 457 433 281	54	293x236x42	
1 457 433 282	54	290x124x57	
1 457 433 285	54	302x117x46	
1 457 433 286	54	288x135x47	
1 457 433 289	54	232x191x50	

nl

Luchtfilterpatronen
(vervolg)

sv

Luftfilterinsatser
(fortsättning)

cs

Vložky vzduchového filtru
(pokračování)

pl

Wkłady filtra powietrza
(ciąg dalszy)

ru

Элементы воздушного
фильтра
(продолжение)

	Fig.	$a \times b \times c$	
		$H \times \emptyset$	mm
1 457 433 290	54	249x159x40	
1 457 433 292	54	500x327	
1 457 433 294	72	253x210x65	
1 457 433 297	54	314x112x63	
1 457 433 298	54	347x174x41	
1 457 433 299*	54	345x57x115	
1 457 433 300	54	327x215x58	
1 457 433 303	54	247x197x37	
1 457 433 306	54	217x168x34	
1 457 433 307	56	270x109	
1 457 433 308	54	341x111x40	
1 457 433 309	54	213x167x37	
1 457 433 310	54	254x213x57	
1 457 433 311	54	202x91x255	
1 457 433 314	54	248x150x49	
1 457 433 315	54	300x155x42	
1 457 433 316	54	282x123x50	
1 457 433 317	54	320x151x40	
1 457 433 319	54	300x155x46	
1 457 433 320	61	279x201x48	
1 457 433 322	102	318x199x42	
1 457 433 323	54	281x190x57	
1 457 433 324	54	232x191x62	
1 457 433 325	54	336x102x57	
1 457 433 326	54	204x164x38	
1 457 433 327	54	250x133x66	
1 457 433 329	65	257x150	
1 457 433 330	59	67x294	
1 457 433 331	54	315x190x58	
1 457 433 332	49	350x164	
1 457 433 333	**	434x120	
1 457 433 334	**	433x120	
1 457 433 336*	**	311x119	
1 457 433 337*	**	426x94x57	
1 457 433 338*	**	254x188x38	

	Fig.	$a \times b \times c$	
		$H \times \emptyset$	mm
1 457 433 339	54	362x237x48	
1 457 433 520	54	325x135x42	
1 457 433 521	59	70x294	
1 457 433 522	54	462x86x70	
1 457 433 523	54	316x190x48	
1 457 433 524	54	340x100x58	
1 457 433 526	54	211x170x42	
1 457 433 527	61	318x175x58	
1 457 433 529	61	176x142x70	
1 457 433 531	54	313x102x42	
1 457 433 532	61	213x220x58	
1 457 433 533	54	279x161x35	
1 457 433 534	59	145x216	
1 457 433 535	54	343x169x58	
1 457 433 536	54	350x217x58	
1 457 433 537	54	258x287x58	
1 457 433 538	56	263x119	
1 457 433 539	54	186x140x50	
1 457 433 540	59	62x278	
1 457 433 541	54	257x124x47	
1 457 433 542	59	59x293	
1 457 433 543	61	318x175x58	
1 457 433 544	56	123x170	
1 457 433 545	54	443x134x33	
1 457 433 546	54	308x184x49	
1 457 433 547	54	260x203x57	
1 457 433 548	54	235x176x57	
1 457 433 549	54	248x207x57	
1 457 433 550	54	249x228x50	
1 457 433 553	56	274x115	
1 457 433 555	61	272x202x58	
1 457 433 557*	**	320x124	
1 457 433 558*	**	361x149	
1 457 433 564	56	420x243	
1 457 433 568	56	404x220	

	Fig.	$a \times b \times c$	
		$H \times \emptyset$	mm
1 457 433 571	54	262x246x58	
1 457 433 573	61	243x192x58	
1 457 433 574	81	360x226x33	
1 457 433 575	61	213x220x70	
1 457 433 576	74	221x136	
1 457 433 577	54	280x158x50	
1 457 433 578	54	326x252x50	
1 457 433 579	54	326x252x50	
1 457 433 580	54	246x210x44	
1 457 433 581	54	307x120x42	
1 457 433 583	54	236x207x64	
1 457 433 584	54	242x193x32	
1 457 433 585	54	174x207x50	
1 457 433 587	61	327x215x58	
1 457 433 588	**	377x89	
1 457 433 589	62	464x145	
1 457 433 590	75	139x176	
1 457 433 591	82	358x152x59	
1 457 433 592	54	354x103x50	
1 457 433 593	54	217x168x34	
1 457 433 594	54	395x182x46	
1 457 433 595	54	239x141x58	
1 457 433 596	54	321x152x40	
1 457 433 599	54	250x104x48	
1 457 433 601	54	598x171x61	
1 457 433 603	54	211x166x37	
1 457 433 605	54	256x177x41	
1 457 433 606	54	297x102x49	
1 457 433 607	54	283x171x58	
1 457 433 608	54	369x150x57	
1 457 433 609	54	397x150x41	
1 457 433 610*	**	110x374	
1 457 433 611*	**	121x381	
1 457 433 616	54	393x166x41	
1 457 433 617	54	198x150x41	

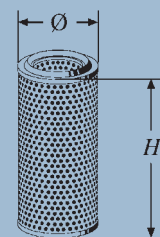
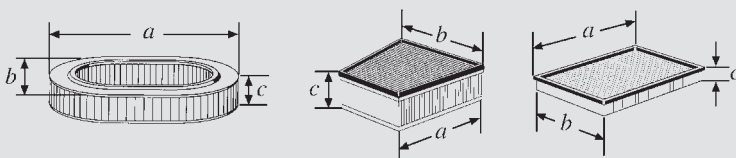

* Neu / New / Nouveau / Nuovo / Nuevo / Nieuwe / Ny / Nové / Nowe / Новые

** siehe Online-Katalog / see online catalog / voir le catalogue en ligne / vedi catalogo online / Ver catálogo online / zie online catalogus / se onlinekatalog / viz katalog online / zobacz katalog online / см. онлайн-каталог

de

Luftfiltereinsätze
(Fortsetzung)

en

Air-filter elements
(continued)

fr

Cartouches de filtres
à air
(suite)

it

Cartucce filtranti
per filtri aria
(seguito)

es

Cartuchos filtrantes
para filtros de aire
(continuación)

	Fig.	$a \times b \times c$	
		$H \times \emptyset$	mm
1 457 433 620	54	230x90x48	
1 457 433 623	54	297x87x43	
1 457 433 624	56	268x130	
1 457 433 626	54	598x171x81	
1 457 433 627	56	231x150	
<hr/>			
1 457 433 642	54	348x185x49	
1 457 433 646	57	210x154	
1 457 433 650	59	110x321	
1 457 433 651	56	364x241	
1 457 433 652	56	162x146	
<hr/>			
1 457 433 654	59	50x287	
1 457 433 655	**	298x235x52	
1 457 433 659	54	258x258x41	
1 457 433 660	54	361x81x48	
1 457 433 670	56	580x270	
<hr/>			
1 457 433 677	56	289x133	
1 457 433 682	60	330x227x60	
1 457 433 686	54	267x148x48	
1 457 433 688	59	67x235	
1 457 433 690	54	241x228x58	
<hr/>			
1 457 433 697	54	233x236x42	
1 457 433 698	54	254x213x57	
1 457 433 699	54	336x190x58	
1 457 433 700	54	332x156x44	
1 457 433 701	54	304x171x58	
<hr/>			
1 457 433 702	56	221x150	
1 457 433 703	54	315x277x81	
1 457 433 711	54	200x140x49	
1 457 433 712	56	262x116	
1 457 433 713	54	166x211x57	
<hr/>			
1 457 433 714	54	364x185x50	
1 457 433 715	57	150x123	
1 457 433 716	73	417x187x32	
1 457 433 722	56	341x238	
1 457 433 726*	56	389x281	
<hr/>			
1 457 433 728	56	317x420	
1 457 433 729	56	263x420	
1 457 433 730	58	405x346	
1 457 433 731*	56	397x308	
1 457 433 734	59	140x198	
<hr/>			
1 457 433 735	56	298x243	
1 457 433 736	54	268x108x57	
1 457 433 739	56	135x91	
1 457 433 740	54	340x206x42	
1 457 433 741	54	223x188x58	

	Fig.	$a \times b \times c$	
		$H \times \emptyset$	mm
1 457 433 742	54	312x211x59	
1 457 433 743	54	214x141x58	
1 457 433 745	56	263x136	
1 457 433 747	54	279x218x58	
1 457 433 748	54	277x315x71	
<hr/>			
1 457 433 749	60	259x189x104	
1 457 433 750	54	312x149x57	
1 457 433 751	54	235x201x46	
1 457 433 752	54	228x294x58	
1 457 433 753	54	331x266x68	
<hr/>			
1 457 433 769	75	168x144	
1 457 433 771	54	242x188x58	
1 457 433 772	54	254x213x69	
1 457 433 773	54	266x125x65	
1 457 433 775	58	420x374	
<hr/>			
1 457 433 781	54	271x118x57	
1 457 433 784	54	225x166x42	
1 457 433 785	55	41x245	
1 457 433 786	58	289x136	
1 457 433 788	54	207x257x38	
<hr/>			
1 457 433 789	54	258x143x58	
1 457 433 790	58	284x163	
1 457 433 791	58	257x151	
1 457 433 792	54	260x150x58	
1 457 433 795	56	279x132	
<hr/>			
1 457 433 796	59	102x182	
1 457 433 797	54	302x175x46	
1 457 433 799	54	340x206x42	
1 457 433 800	58	300x190	
1 457 433 900	56	482x305	
<hr/>			
1 457 433 901	56	468x327	
1 457 433 903	58	446x303	
1 457 433 904	58	526x303	
1 457 433 950	54	247x138x40	
1 457 433 951	54	184x207x42	
<hr/>			
1 457 433 952	54	249x169x51	
1 457 433 953	54	189x154x52	
1 457 433 954	54	201x220x44	
1 457 433 955	54	190x200x46	
1 457 433 956	54	230x201x55	
<hr/>			
1 457 433 957	54	249x119x51	
1 457 433 958	54	266x171x43	
1 457 433 959	54	240x157x38	
1 457 433 961	54	208x153x39	
1 457 433 962	54	245x203x40	

	Fig.	$a \times b \times c$	
		$H \times \emptyset$	mm
1 457 433 963	54	211x202x40	
1 457 433 965	54	225x224x37	
1 457 433 966	61	265x251x51	
1 457 433 968	54	230x185x52	
1 457 433 969	54	216x205x52	
<hr/>			
1 457 433 970	54	300x184x54	
1 457 433 971	54	257x115x44	
1 457 433 972	54	249x120x54	
<hr/>			
1 987 ...			
1 987 429 036	60	371x167x47	
1 987 429 042	56	183x125	
1 987 429 046	60	275x226x62	
<hr/>			
1 987 429 051	54	278x167x31	
1 987 429 109	60	242x152x147	
1 987 429 115	59	60x193	
1 987 429 117	56	170x127	
1 987 429 120	54	230x195x48	
<hr/>			
1 987 429 121	59	60x260	
1 987 429 122	59	47x255	
1 987 429 123	54	222x164x53	
1 987 429 125	75	111x177	
1 987 429 127	59	175x196	
<hr/>			
1 987 429 128	54	338x138x34	
1 987 429 133	55	41x255	
1 987 429 135	54	309x155x43	
1 987 429 136	54	204x173x38	
1 987 429 137	54	248x154x42	
<hr/>			
1 987 429 146	54	248x149x35	
1 987 429 148	55	44x275	
1 987 429 149	55	36x244	
1 987 429 150	60	284x222x46	
1 987 429 151	54	308x185x42	
<hr/>			
1 987 429 152	54	312x150x45	
1 987 429 154	58	162x158	
1 987 429 155	58	290x133	
1 987 429 156	56	292x132	
1 987 429 157	59	145x219	
<hr/>			
1 987 429 158	56	145x197	
1 987 429 159	55	45x259	
1 987 429 160	54	310x166x42	
1 987 429 161	54	60x268	
1 987 429 162	54	310x200x42	

nl Luchtfilterpatronen (vervolg)	sv Luftfilterinsatser (fortsättning)	cs Vložky vzduchového filtru (pokračování)	pl Wkłady filtra powietrza (ciąg dalszy)	ru Элементы воздушного фильтра (продолжение)
---	---	---	---	---

	Fig.	$a \times b \times c$ $H \times \varnothing$ mm
1 987 429 163	54	375x135x54
1 987 429 164	54	185x170x53
1 987 429 166	76	203x190x35
1 987 429 167	54	264x135x28
1 987 429 169	54	196x158
1 987 429 170	60	342x245x37
1 987 429 171	54	306x120x44
1 987 429 172	59	46x215
1 987 429 173	77	160x307
1 987 429 174	54	268x188x37
1 987 429 175	54	179x162x61
1 987 429 176	78	312x194x44
1 987 429 177	79	266x116x63
1 987 429 178	80	323x214x42
1 987 429 179	54	340x171x35
1 987 429 180	54	298x237x34
1 987 429 181	54	274x165x32
1 987 429 182	54	207x168x80
1 987 429 183	54	317x163x58
1 987 429 184	54	315x200x37
1 987 429 185	54	274x167x42
1 987 429 186	54	200x155
1 987 429 187	54	318x193x43
1 987 429 188	54	319x176x48
1 987 429 189	54	291x211x41
1 987 429 190	54	390x186x59
1 987 429 191	81	332x109x41
1 987 429 192	82	339x151x45
1 987 429 193	54	296x235x48
1 987 429 194	54	237x214x43
1 987 429 400	56	185x152
1 987 429 401	62	249x133
1 987 429 402	54	249x211x40
1 987 429 403	54	300x155x42
1 987 429 404	54	345x136x70

	Fig.	$a \times b \times c$ $H \times \varnothing$ mm
1 987 429 405	83	221x136
1 987 429 406	61	243x192x58
F 026 ...		
F 026 400 001	54	265x172x32
F 026 400 002	**	375x144x53
F 026 400 004	54	288x247x39
F 026 400 006	54	249x116x62
F 026 400 007	54	312x188x67
F 026 400 010	54	206x170x92
F 026 400 011	**	179x107
F 026 400 012	54	292x224x42
F 026 400 013	**	292x234x42
F 026 400 014	**	316x262x42
F 026 400 015	54	289x154x50
F 026 400 016	**	254x124x45
F 026 400 017	**	289x150x51
F 026 400 018	**	200x142
F 026 400 019	73	420x188x32
F 026 400 020	**	329x248x42
F 026 400 023	87	187x170x70
F 026 400 024	**	338x120
F 026 400 025	54	237x192x50
F 026 400 026	70	225x211x72
F 026 400 027	75	167x151
F 026 400 028	**	192x166
F 026 400 029	**	174x176
F 026 400 030	**	268x265x50
F 026 400 033	54	282x180x57
F 026 400 034	49	410x352
F 026 400 035	**	372x190x42
F 026 400 036	**	279x97x60

	Fig.	$a \times b \times c$ $H \times \varnothing$ mm
F 026 400 037	54	231x144x43
F 026 400 038	**	309x155x52
F 026 400 039	66	246x141
F 026 400 040	75	121x214
F 026 400 041	54	272x172x54
F 026 400 042	**	225x188x37
F 026 400 043	**	224x180x46
F 026 400 044	**	252x172x46
F 026 400 045	54	253x149x37
F 026 400 046	**	228x188
F 026 400 047	54	238x142x58
F 026 400 048	**	266x132x56
F 026 400 049	**	212x202x58
F 026 400 050	**	495x85x56
F 026 400 051	**	377x83x80
F 026 400 052	54	247x197x58
F 026 400 053	54	317x152x31
F 026 400 054	**	170x147x54
F 026 400 055	**	353x265x57
F 026 400 056	54	183x170x57
F 026 400 057	54	212x202x58
F 026 400 058	**	345x147x70
F 026 400 059	65	303x169
F 026 400 060	**	252x114x39
F 026 400 061	75	175x140
F 026 400 062	**	248x167x37
F 026 400 063	**	190x200x50
F 026 400 064	**	510x267
F 026 400 067	**	383x249
F 026 400 068	**	486x267
F 026 400 069	56	339x214
F 026 400 070	56	417x214
F 026 400 071	**	481x265
F 026 400 072	**	419x267
F 026 400 073*	**	391x232

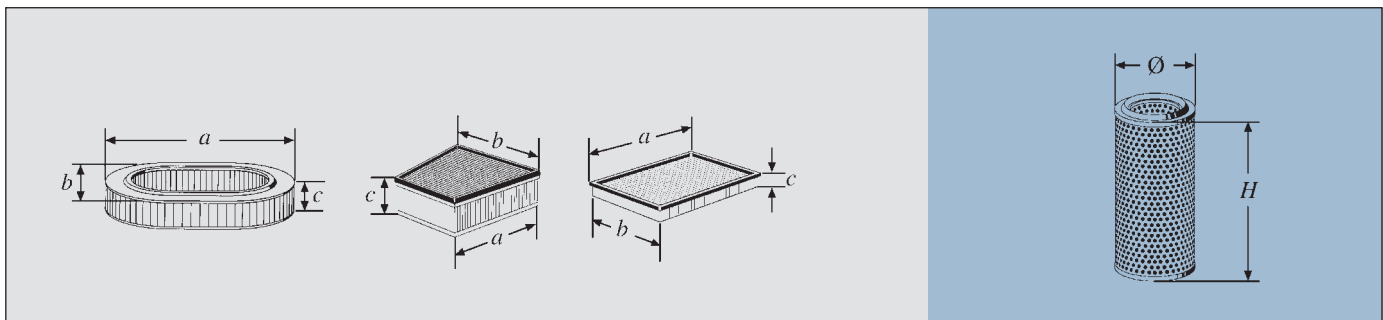

* Neu / New / Nouveau / Nuovo / Nuevo / Nieuwe / Ny / Nové / Nowe / Новые

** siehe Online-Katalog / see online catalog / voir le catalogue en ligne / vedi catalogo online / Ver catálogo online / zie online catalogus / se onlinekatalog / viz katalog online / zobacz katalog online / см. онлайн-каталог

de

Luftfiltereinsätze
(Fortsetzung)

en

Air-filter elements
(continued)

fr

Cartouches de filtres
à air
(suite)

it

Cartucce filtranti
per filtri aria
(seguito)

es

Cartuchos filtrantes
para filtros de aire
(continuación)

	Fig.	a x b x c	
		H x Ø	mm
F 026 400 074	**	310x248	
F 026 400 075	**	391x248	
F 026 400 076*	**	461x301	
F 026 400 077	56	500x328	
F 026 400 078	**	468x327	
F 026 400 079	**	606x575	
F 026 400 080	**	421x314	
F 026 400 082	56	345x82	
F 026 400 083	65	463x310	
F 026 400 084	65	505x281	
F 026 400 085	**	592x206	
F 026 400 086	65	556x310	
F 026 400 087	65	281x480	
F 026 400 088	**	346x520	
F 026 400 090	**	242x163x55	
F 026 400 091	**	270x174x60	
F 026 400 092	56	280x145	
F 026 400 093	**	262x132x48	
F 026 400 094	**	626x563x78	
F 026 400 095	**	197x144	
F 026 400 096	54	257x222x46	
F 026 400 097	54	212x200x58	
F 026 400 098	87	230x197x44	
F 026 400 099	54	303x224x55	
F 026 400 101	54	232x137x34	
F 026 400 102	**	454x89x50	
F 026 400 103	54	280x296x57	
F 026 400 104	54	270x182x58	
F 026 400 105	54	294x171x50	
F 026 400 106	54	271x249x47	
F 026 400 107	54	268x144x44	
F 026 400 109	**	300x240x70	
F 026 400 110	61	199x172x38	
F 026 400 111	**	290x258x43	
F 026 400 112	54	340x170x45	
F 026 400 113	54	304x196x60	
F 026 400 114	**	239x175x54	
F 026 400 117	58	411x303	
F 026 400 119	87	300x234x62	
F 026 400 120	54	245x186x62	
F 026 400 121	54	305x144x85	
F 026 400 122	54	419x227x42	
F 026 400 123	54	260x180x39	
F 026 400 125	**	228x178x53	
F 026 400 126	61	232x163x58	

	Fig.	a x b x c	
		H x Ø	mm
F 026 400 127	76	234x178x30	
F 026 400 128*	**	274x103x78	
F 026 400 129	76	276x187x53	
F 026 400 130	54	183x169x33	
F 026 400 131	**	306x195	
F 026 400 132	87	199x168x46	
F 026 400 133	**	350x176x96	
F 026 400 134	**	314x146x48	
F 026 400 135	54	197x166x71	
F 026 400 136	65	211x157	
F 026 400 137	**	249x130x55	
F 026 400 138	61	247x192x56	
F 026 400 139	61	207x192x58	
F 026 400 140	54	304x144x62	
F 026 400 143	**	314x149x76	
F 026 400 144	54	269x111x36	
F 026 400 145	**	461x312	
F 026 400 146	70	238x209x56	
F 026 400 147	**	674x134x45	
F 026 400 148	**	353x287x35	
F 026 400 149	61	271x251x48	
F 026 400 150	54	279x167x70	
F 026 400 151	54	360x145x44	
F 026 400 152	54	310x156x25	
F 026 400 153	54	222x187x36	
F 026 400 154	**	332x136x36	
F 026 400 156	**	170x149	
F 026 400 157	54	322x128x58	
F 026 400 158	**	335x174x53	
F 026 400 159	68	292x199x46	
F 026 400 160	**	306x182x44	
F 026 400 161	68	195x135x44	
F 026 400 162	70	280x232x51	
F 026 400 163	**	288x223x36	
F 026 400 164	54	234x188x41	
F 026 400 165	76	248x199x52	
F 026 400 166	54	285x249x51	
F 026 400 167*	**	223x192x27	
F 026 400 168*	**	273x167x42	
F 026 400 169*	**	220x119x51	
F 026 400 170*	**	290x185x27	
F 026 400 171*	**	268x234x86	
F 026 400 172*	**	344x135x78	
F 026 400 173*	**	278x188x37	
F 026 400 174*	**	353x102x65	

	Fig.	a x b x c	
		H x Ø	mm
F 026 400 175*	**	282x169x58	
F 026 400 176	**	240x236x86	
F 026 400 177*	**	218x166x38	
F 026 400 178	**	405x174x33	
F 026 400 179	**	416x356	
F 026 400 180*	**	346x223x50	
F 026 400 181	70	350x223x47	
F 026 400 182*	**	389x186x63	
F 026 400 183*	**	184x175	
F 026 400 184	**	500x250	
F 026 400 186*	**	279x133	
F 026 400 187*	**	255x174x41	
F 026 400 188	**	252x238x56	
F 026 400 189	56	357x186	
F 026 400 191*	**	237x143x31	
F 026 400 192*	**	239x235x51	
F 026 400 193*	**	120x219	
F 026 400 194*	**	262x146	
F 026 400 196*	**	496x329	
F 026 400 198	**	192x166	
F 026 400 199	58	228x145	
F 026 400 200*	**	270x185x53	
F 026 400 201	**	226x127x35	
F 026 400 202*	**	282x180x62	
F 026 400 203*	**	285x229x50	
F 026 400 204*	**	220x139	
F 026 400 205	**	435x119	
F 026 400 206*	**	218x221x32	
F 026 400 207	**	416x332	
F 026 400 209	65	305x227	
F 026 400 211	65	414x232	
F 026 400 212	54	235x192x58	
F 026 400 213	**	167x162	
F 026 400 214*	**	338x119	
F 026 400 215	**	250x209x35	
F 026 400 216	**	273x195x33	
F 026 400 217*	**	268x260x37	
F 026 400 218*	**	293x200x43	
F 026 400 219*	**	360x144x40	
F 026 400 220*	**	346x204x50	
F 026 400 221*	**	238x240x68	
F 026 400 222*	**	229x168x33	
F 026 400 223*	**	177x166x60	
F 026 400 224*	**	180x153x42	
F 026 400 225*	**	312x232x52	

de

Kraftstofffilter für Diesel-
motoren – Filterboxen

en

Fuel filters for diesel
engines – Box-type filters

fr

Filtres à carburant
pour moteurs diesel –
Filtres-box

it

Filtri carburante
per motori diesel –
Cartucce filtranti

es

Filtros de combustible
para motores diesel –
Filtros-caja

	Fig.		H mm	\varnothing mm	A
---	------	---	-----------	---------------------	---

0 986 ...

0 986 450 508	47	0,5	135	98	M 20 x 1,5
----------------------	----	-----	-----	----	------------

1 457 ...

1 457 070 001	48		97	67	
1 457 429 675	47	0,8	142	96	M 16 x 1,5
1 457 429 676	47	1,2	177	94	M 16 x 1,5

1 457 429 681	81	0,8	186	110	3/4" 16 UNF
1 457 431 703	1	0,3	81	95	
1 457 434 050	47	0,5	124	83	M 16 x 1,5
1 457 434 051	47	0,4	92	84	M 16 x 1,5
1 457 434 062	**				

1 457 434 103	13	0,5	130	83	M 16 x 1,5
1 457 434 105	13	0,6	155	83	M 16 x 1,5
1 457 434 106	13	0,6	156	83	M 16 x 1,5
1 457 434 123	47	0,5	100	84	M 12 x 1,5
1 457 434 150	13	0,8	182	83	M 16 x 1,5

1 457 434 153	47	0,4	92	84	M 14 x 1,5
1 457 434 154	47	0,5	124	83	M 16 x 1,5
1 457 434 165	47				
1 457 434 174	13	0,8	161	83	M 16 x 1,5
1 457 434 180	**	0,8	178	95	1" 14 UNF

1 457 434 184*	13	0,8	182	83	M 16 x 1,5
1 457 434 186	47	0,9	136	109	M 10 x 1,5
1 457 434 187	13	1,0	184	84	M 16 x 1,5
1 457 434 192	47	0,6	144	83	M 16 x 1,5
1 457 434 194	13	0,6	157	83	M 16 x 1,5

1 457 434 198	47	0,8	169	83	M 16 x 1,5
1 457 434 200	14	0,8	112	88	
1 457 434 201	14	0,5	72	88	
1 457 434 281	12	0,9	145	97	3/4" 16 UNF
1 457 434 291	13	0,5	112	80	M 16 x 1,5

1 457 434 293	13	0,8	184	83	M 16 x 1,5
1 457 434 294	47	0,8	212	96	M 18 x 1,5
1 457 434 295	47	0,5	126	83	M 16 x 1,5
1 457 434 296	12	0,6	130	83	M 16 x 1,5
1 457 434 302	12	0,9	137	95	M 20 x 1,5

1 457 434 306	12	0,6	145	83	M 16 x 1,5
1 457 434 310	47	0,8	166	83	M 16 x 1,5
1 457 434 314	47	0,6	144	83	M 16 x 1,5
1 457 434 321	13	0,4	128	83	M 16 x 1,5
1 457 434 324	47	0,8	182	83	M 16 x 1,5

	Fig.		H mm	\varnothing mm	A
---	------	---	-----------	---------------------	---

1 457 434 329	13	0,6	158	83	M 16 x 1,5
1 457 434 331	**		100	84	
1 457 434 400	13	0,5	129	90	M 14 x 1,5
1 457 434 402	13	0,8	195	99	M 14 x 1,5
1 457 434 405	12	0,8	186	83	M 16 x 1,5

1 457 434 408*	13	0,6	162	89	
1 457 434 409	47	0,8	144	93	M 16 x 1,5
1 457 434 419	47	1,0	144	96	M 16 x 1,5
1 457 434 421	47	1,0	144	96	M 18 x 1,5
1 457 434 423	47	1,4	210	93	1" 14 UNF

1 457 434 428	47	1,0	142	96	M 24 x 1,5
1 457 434 429	47	1,4	212	96	M 16 x 1,5
1 457 434 432	12	0,4	125	78	M 16 x 1,5
1 457 434 433	**		73	79	
1 457 434 435	47	0,5	122	84	M 20 x 1,5

1 457 434 436	13	0,6	132	84	M 16 x 1,5
1 457 434 438	47	0,4	130	94	3/4" 16 UNF
1 457 434 439	12		155	96	3/4" 16 UNF
1 457 434 440	12		123	72	
1 457 434 443	12		97	84	M 16 x 1,5

1 457 434 447	13		156	80	M 16 x 1,5
1 457 434 448	11		107	97	
1 457 434 450	12		75	108	
1 457 434 451	13		155	95	
1 457 434 452	47		97	95	M 20 x 1,5

1 457 434 453	47		130	94	
1 457 434 454	12		104	80	M 20 x 1,5
1 457 434 455	47		159	88	M 16 x 1,5
1 457 434 456	12		121	99	M 20 x 1,5
1 457 434 459	12		143	98	M 22 x 1,5

1 457 434 460	13		150	84	M 16 x 1,5
1 457 434 510	**		142	83	
1 457 434 511	**		141	83	
1 457 434 516	**		144	83	

F 026 ...

F 026 402 002	12	12	162	83	
F 026 402 013	13	13	171	88	
F 026 402 017*	14	14	263	113	

F 026 402 025	13		157	112	
F 026 402 030	47		175	95	
F 026 402 034	47		168	110	
F 026 402 035	14		212	97	
F 026 402 036*	13		184	97	

de

Filtereinsätze

en

Filter elements

fr

Cartouches de filtre

it

Cartucce filtranti

es

Cartuchos filtrantes

	Fig.		H mm	Ø mm
---	------	---	---------	---------

0 450 ...

0 450 904 162	**	0,2	126	48
----------------------	----	-----	-----	----

0 986 ...

0 986 450 508	47	0,6	136	98
----------------------	----	-----	-----	----

1 457 ...

1 457 030 013	48	0,5	76	84
1 457 070 000	48		66	79
1 457 070 001	48		97	67

1 457 070 007	48		142	59
1 457 070 008	**		136	79
1 457 070 010	**		84,5	102
1 457 429 225	**	0,3	133	40
1 457 429 230	49	0,2	68	51

1 457 429 289	49	0,5	102	63
1 457 429 291	49	0,4	61	81
1 457 429 354	11	1,0	145	85
1 457 429 359	50	0,5	115	70
1 457 429 621	14	0,4	87	78

1 457 429 655	49	1,2	204	106
1 457 429 656	49	0,5	96	70
1 457 429 657	49	0,2	51	70
1 457 431 028	49	0,5	52	63
1 457 431 158	48	0,5	115	59

1 457 431 159	48	1,1	145	85
1 457 431 261	50	0,5	116	65
1 457 431 270	49	1,1	144	82
1 457 431 325	2	0,5	115	67
1 457 431 326	2	1,1	145	82

1 457 431 702	49	0,4	87	78
1 457 431 703	1	0,3	81	95
1 457 431 704	48	0,4	90	77
1 457 431 705	48	0,4	93	70
1 457 431 707	48	0,7	103	92

1 457 431 708	48	1,0	123	82
1 457 431 710	49	1,1	230	78
1 457 431 712	48	0,3	79	78
1 457 431 713	48	0,3	60	80
1 457 431 718	**		115	76

	Fig.		H mm	Ø mm
---	------	---	---------	---------

1 457 431 720	48		96	78
1 457 431 723	48		74	92
1 457 431 724	48		120	71
1 457 431 729	51		99	102
1 457 434 156	47		142	83

1 457 434 187	13	1,0	184	84
1 457 434 281	12	0,9	145	97
1 457 434 438	47	0,4	130	94
1 457 434 440	12		123	72
1 457 434 448	14		107	97

1 457 434 511	**		141	83
----------------------	----	--	-----	----

F 026 ...

F 026 402 002	47		162	83
F 026 402 004	48		118	84
F 026 402 005	**		109	71



F 026 402 007	58		110	78
F 026 402 008	48		116	84
F 026 402 025	**		157	112
F 026 402 028	**		174	95
F 026 402 029	**		230	76

F 026 402 031	**		259	105
F 026 402 032	**		250	105
F 026 402 033	**		105	105
F 026 402 047	48		90	70
F 026 402 062	**		91	89



F 026 402 070	**		163	95
F 026 402 093*	**		90	71
F 026 402 100*	**		187	85
F 026 402 101*	**		134	71
F 026 402 107*	**		188	87

F 026 402 115*	**		76,5	84
F 026 402 119*	**		154	88
F 026 402 120*	**		74	92
F 026 402 121*	**		196	83
F 026 402 122*	**		197	88

F 026 402 128	**		112,5	81
F 026 402 134*	**		55	88,8
F 026 402 136*	**		41,2	50
F 026 402 809*	**		134,7	93,5
F 026 402 810*	**		90	71

			H mm	\varnothing mm	B \varnothing mm ↓	B \varnothing mm ↑
0 450 ...						
0 450 902 161	16	0,2	143	62		
0 450 904 058	17	0,1	105	35		
0 450 904 060	18	0,1	104	35		
0 450 904 077	19	0,1	105	37	-	-
0 450 904 149	17	0,1	142	37	-	-
0 450 904 158	18		108	50	-	-
0 450 904 159	17	0,1	108	50	-	-
0 450 904 161	20	0,1	65	44	-	-
0 450 904 162		0,2	126	48	-	-
0 450 904 163	18		134	42	-	-
0 450 905 200	21	0,6	152	81	-	-
0 450 905 326	35	0,2	121	62	-	-
0 450 905 601	21	0,6	152	88	-	-
0 450 905 912	21	0,2	116	70	-	-
0 450 905 915	24	0,2	109	70	-	-
0 450 905 921	35	0,6	165	87	-	-
0 450 905 930	23	0,3	128	91	-	-
0 450 905 978	42		152	65	-	-
0 450 905 982	**		150	82	-	-
0 450 905 990	39		104	65	-	-
0 450 906 172	25	0,6	153	89	-	-
0 450 906 174	23	0,6	175	89	-	-
0 450 906 261	25	0,6	168	81	-	-
0 450 906 267	23	0,6	175	89	-	-
0 450 906 274	23	0,6	168	89	-	-
0 450 906 281	23	0,6	201	89	-	-
0 450 906 295	23	0,6	201	89	-	-
0 450 906 308	23	0,6	201	89	-	-
0 450 906 318	23	0,6	174	89	-	-
0 450 906 322	23	0,6	174	89	-	-
0 450 906 334	23	0,6	153	89	-	-
0 450 906 357	23	0,6	175	89	-	-
0 450 906 373	23	0,6	172	89	-	-
0 450 906 374	23	0,6	201	89	-	-
0 450 906 376	23	0,8	201	89	-	-
0 450 906 406	23	0,6	190	100	-	-
0 450 906 407	23	0,6	190	89	-	-
0 450 906 409	23	0,6	155	89	-	-
0 450 906 426	30		125	91	-	-
0 450 906 429	30		135	89	-	-
0 450 906 431	**		168	85	-	-
0 450 906 437	23		176	89	-	-
0 450 906 442	25	0,8	190	89	-	-

nl	sv	cs	pl	ru
Leidingfilters	Ledningsfilter	Filtr na vedení	Filtry przewodów	Прямоточные фильтры

	Fig.		H mm	\varnothing mm	B \varnothing mm ↓	B \varnothing mm ↑
0 450 906 450	22	0,7	274	55	-	-
0 450 906 451	27	0,7	177	84	-	-
0 450 906 452	23	0,7	182	88	-	-
0 450 906 453	23	0,7	181	87	-	-
0 450 906 457	21		226	55	-	-
0 450 906 458	30	0,4	131	113	-	-
0 450 906 459	30	0,7	205	86	-	-
0 450 906 460	29		124	107	-	-
0 450 906 461	**		168	117	-	-
0 450 906 462	22	0,7	274	55	-	-
0 450 906 463	22	0,7	274	56	-	-
0 450 906 464	25	0,3	122	91	-	-
0 450 906 467	28		276	81	-	-
0 450 906 468	**		188	133	-	-
0 450 906 469	**		188	133	-	-
0 450 906 473	**		189	112	-	-
0 450 906 500	44		110	90	-	-
0 450 906 503	25		183	90	-	-
0 450 906 508	15		188	89	-	-
0 450 906 511	**		149	80	-	-
0 450 907 006	**		122		-	-
0 450 907 007	**		132		-	-
0 450 907 008	**		185	74	-	-
0 450 907 011	**		185	74	-	-
0 450 907 016	**		188		-	-
0 986 ...						
0 986 450 018	20	0,1	86	44	-	-
0 986 450 030	32	0,1	76	87	-	-
0 986 450 037	34	0,1	66	84	-	-
0 986 450 039	20	0,1	59	49	-	-
0 986 450 120	24	0,2	109	55	-	-
0 986 450 212	31	0,2	108	57	-	-
0 986 450 221	24	0,3	123	70	-	-
0 986 450 222	**	0,2	151	70	-	-

Schlauchanschluss
Hose connection
Raccord de flexible
Raccordo tubo
Racor para tubo flexible
Slangaansluiting
Slanganslutning
Hadicové připojení
Przyłącze wężyka
Подсоединение шланга

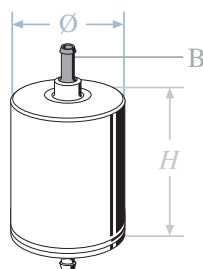

* Neu / New / Nouveau / Nuovo / Nuevo / Nieuwe / Ny / Nové / Nowe / Новые

** siehe Online-Katalog / see online catalog / voir le catalogue en ligne / vedi catalogo online / Ver catálogo online / zie online catalogus / se onlinekatalog / viz katalog online / zobacz katalog online / см. онлайн-каталог

de

Leitungsfiler
(Fortsetzung)

en

In-line filters
(continued)

fr

Filtres de conduite
(suite)

it

Filtri per tubazioni
(seguito)

es

Filtros de tubería
(continuación)

Fig.

 $\frac{H}{\text{mm}}$ $\frac{\varnothing}{\text{mm}}$ B $\frac{\varnothing}{\text{mm}}$ ↓B $\frac{\varnothing}{\text{mm}}$ ↑

Part Number	Fig.	Filter Element	H (mm)	Ø (mm)	B Ø (mm) ↓	B Ø (mm) ↑
0 986 450 509	30	0,6	164	88	-	-

1 457 ...

1 457 434 329	13	0,6	158	83	-	-
1 457 434 416	**	0,7	127	91	-	-
1 457 434 437	25	0,4	125	92	-	-
1 457 434 457	**		110	86	-	-

F 026 ...

F 026 402 001	35		136	55	-	-
F 026 402 002	47		162	83	-	-
F 026 402 003	27		120	92	-	-
F 026 402 016	**		120	93	-	-
F 026 402 019	23		120	98	-	-
F 026 402 044	**		120	92	-	-
F 026 402 045	**		233	100	-	-
F 026 402 046	**		125	103	-	-
F 026 402 049	**		205	90	-	-
F 026 402 051	**		193	90	-	-
F 026 402 054	**		205	90	-	-
F 026 402 056	23		126	92	-	-
F 026 402 059*	**		137	98	-	-
F 026 402 061	**		120	98	-	-
F 026 402 065	30		125	92	-	-
F 026 402 066	22		250	56	-	-
F 026 402 067	**		177	98	-	-
F 026 402 068	35		250	56	-	-
F 026 402 072	**		93	98	-	-
F 026 402 073	**		187	133	-	-
F 026 402 074	**		187	133	-	-
F 026 402 075	**		210	86,5	-	-
F 026 402 076	**		204	85	-	-
F 026 402 077	**		187	133	-	-
F 026 402 080	**		188	133	-	-
F 026 402 081	13		143	95	-	-
F 026 402 082	**		158	95	-	-
F 026 402 084	**		98	75	-	-

nl

Leidingfilters
(vervolg)

sv

Ledningsfilter
(fortsättning)

cs



Filtr na vedení
(pokračování)

pl

Filtry przewodów
(ciąg dalszy)

ru

Прямоточные фильтры
(продолжение)

	Fig.		H mm	\emptyset mm	B mm 	B mm 
F 026 402 085	**		250,5	55,1	-	-
F 026 402 086	**		157	81	-	-
F 026 402 090	**		187	133	-	-
F 026 402 091	**		187	133	-	-
F 026 402 092	**		272	80	-	-
<hr/>						
F 026 402 095	**		286	55	-	-
F 026 402 098	**		187	133	-	-
F 026 402 103*	**		117	87	-	-
F 026 402 104*	**		135	87	-	-
F 026 402 106*	**		256,5	66,5	-	-
<hr/>						
F 026 402 108*	**		126,5	98	-	-
F 026 402 111*	**		250	56	-	-
F 026 402 113*	**		187	87	-	-
F 026 402 124*	**		136	61	-	-
F 026 402 125*	**		120	98	-	-
<hr/>						
F 026 402 126*	**		142	98	-	-
F 026 402 808*	**		250	55,5	-	-
F 026 403 001	**		123	76	-	-
F 026 403 005*	**		116	51	-	-
F 026 403 009	35		182	55	-	-
<hr/>						
F 026 403 014*	**		139	55	-	-
F 026 403 755*	**		152	70	-	-
F 026 403 757*	**		120	70	-	-

Schlauchanschluss
Hose connection
Raccord de flexible
Raccordo tubo
Racor para tubo flexible
Slangaansluiting
Slanganslutning
Hadicové připojení
Przyłącze wężyka
Подсоединение шланга

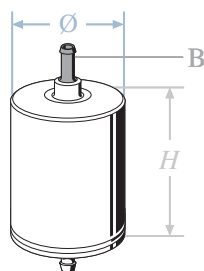

* Neu / New / Nouveau / Nuovo / Nuevo / Nieuwe / Ny / Nové / Nowe / Новые

** siehe Online-Katalog / see online catalog / voir le catalogue en ligne / vedi catalogo online / Ver catálogo online / zie online catalogus / se onlinekatalog / viz katalog online / zobacz katalog online / см. онлайн-каталог

de	en	fr	it	es
Ersatzteile für Kraftstoff- filter/-aggregate	Spare parts for fuel filter/ assemblies	Pièces de rechange pour filtres à carburant/unités	Ricambi per filtri carburante/gruppi filtro	Repuestos para filtros Combustible/ Filtros Completos



0 450 106 010								
0 450 117 003								
0 450 117 007								
0 450 126 001	1 457 434 051				2 916 710 602	1 453 453 017	1 455 523 009	1 450 508 009
0 450 126 002	1 457 434 051					1 453 453 017	1 455 522 014	1 450 508 009
0 450 126 006	1 457 434 106					1 453 465 017	1 455 523 345	
0 450 126 010								
0 450 126 111	1 457 434 150					1 453 465 017	1 455 522 052	
0 450 126 190	1 457 434 105	1 455 711 006			1 450 206 005	1 453 453 017		
					2 916 710 602			
0 450 126 246								
0 450 126 266	1 457 434 105					1 453 465 009	1 455 523 345	1 450 508 009
0 450 126 267 ^{1) 2)}	1 457 434 310	1 455 711 005	1 457 202 004		1 450 206 005	1 453 453 017	1 455 523 059	1 450 508 014
					2 916 710 609			
0 450 126 268 ^{1) 2)}	1 457 434 310	1 455 711 005	1 457 202 004				1 455 523 059	1 450 508 014
0 450 126 269 ^{1) 2)}	1 457 434 310	1 455 711 005	1 457 202 004				1 455 523 059	1 450 508 014
0 450 132 001	1 457 434 154				2 916 710 602	1 453 453 017	1 455 523 009	1 450 508 009
0 450 132 002	1 457 434 154				2 916 710 602	1 453 453 017	1 455 522 014	1 450 508 009
0 450 132 074	1 457 434 051				2 916 710 602	1 453 453 017	1 455 523 027	1 450 508 009
0 450 132 220								1 450 508 009
0 450 133 007	1 457 434 106					1 453 465 017		1 450 508 009
0 450 133 009	1 457 434 106					1 453 465 017		1 450 508 009
0 450 133 012	1 457 434 099				2 916 710 602	1 453 453 017		1 450 508 009
0 450 133 013	1 457 434 105					1 453 465 009		1 450 508 009
0 450 133 071	1 457 434 105					1 453 465 009		1 450 508 009
0 450 133 075	1 457 434 099				2 916 710 602	1 453 453 017		1 450 508 009
0 450 133 154	1 457 434 105	1 455 711 001	1 457 202 002			1 453 465 009	1 455 522 014	1 450 508 009
0 450 133 171	1 457 434 322						1 455 522 014	1 450 508 009
0 450 133 176	1 457 434 105					1 453 465 009		1 450 508 009
0 450 133 186	1 457 434 105	1 455 711 006	1 457 202 004			1 453 465 009		1 450 508 009
0 450 133 197	1 457 434 322							
0 450 133 211	1 457 434 106					1 453 465 017		
0 450 133 213	1 457 434 105	1 455 711 006	1 457 202 004			1 453 465 009		
0 450 133 255	1 457 434 194	1 455 711 006	1 457 202 004			1 453 465 009	1 455 522 090	1 450 508 009
0 450 133 256	1 457 434 105	1 455 711 006	1 457 202 004			1 453 465 009	1 455 522 071	1 450 508 009
0 450 133 270								
0 450 133 272	1 457 434 293	1 455 711 005	1 457 202 004	1 417 413 061		1 453 465 017	1 455 522 101	1 450 508 014
0 450 133 275	1 457 434 105	1 455 711 006	1 457 202 004			1 453 465 009		1 450 508 009
0 450 133 278	1 457 434 322		1 457 202 004			1 453 465 009	1 455 522 113	1 450 508 025
0 450 133 280	1 457 434 293	1 455 711 005	1 457 202 004	1 417 413 061		1 453 465 017	1 455 522 101	1 450 508 009
0 450 133 281	1 457 434 293	1 455 711 005	1 457 202 004	1 417 413 061		1 453 465 017	1 455 522 127	1 450 508 014
0 450 133 283	1 457 434 293	1 455 711 005	1 457 202 004	1 417 413 061		1 453 465 017	1 455 522 101	
0 450 133 288 ²⁾	1 457 434 306	1 455 711 005	1 457 202 004	1 417 413 061			1 455 522 101	1 450 510 001
0 450 133 289 ²⁾	1 457 434 306	1 455 711 005	1 457 202 004	1 417 413 061			1 455 522 101	1 450 508 014
0 450 133 290 ²⁾	1 457 434 198	1 455 711 005	1 457 202 004	1 417 413 061			1 455 522 101	1 450 508 014
	1 457 434 293					1 453 465 017		1 450 508 009
0 450 133 300 ^{1) 2)}	1 457 434 314	1 455 711 005	1 457 202 004	1 417 413 061			1 455 522 101	1 450 508 014
0 450 133 301 ²⁾	1 457 434 198	1 455 711 005	1 457 202 004	1 417 413 061			1 455 522 101	1 450 508 014
0 450 133 302 ^{1) 2)}	1 457 434 310	1 455 711 005	1 457 202 004				1 455 522 154	1 450 508 014
0 450 134 014	1 457 434 106				2 916 710 602	1 453 465 017	1 455 525 041	1 450 508 009
0 450 134 073	1 457 434 106				2 916 710 602	1 453 465 017	1 455 525 044	1 450 508 009
0 450 136 005	1 457 434 105				2 916 710 602	1 453 465 009	1 455 525 043	1 450 508 009
0 450 136 007	1 457 434 154				2 916 710 602	1 453 465 017	1 455 525 043	1 450 508 009
0 450 136 167	1 457 434 159				2 916 710 602	1 453 465 009	1 455 525 043	1 450 508 009
0 450 136 205	1 457 434 295				2 916 710 602			

nl	sv	cs	pl	ru
Onderdelen voor brandstoftilters/-aggregaten	Reservdelar för bränslefilter/-aggregat	Náhradní díly pro palivové filtry/agregáty	Części zamienne do filtrów/pomp paliwa	Запчасти к топливным фильтрам/агрегатам



0 450 136 212	1 457 434 105	1 455 711 006	1 457 202 004					
0 450 136 214	1 457 434 154	1 455 711 006	1 457 202 004					
0 450 138 002								
0 450 198 169						1 453 465 017		1 450 508 025
0 450 226 023	1 457 434 159							
0 450 907 001	1 457 030 013 ³⁾							
0 450 907 002	1 457 030 013 ³⁾							

- | | | |
|----------------|-------------------|------------------------|
| 1) Common Rail | 2) Wassersensor | 3) Filterelement |
| 1) Common Rail | 2) Water sensor | 3) Filter element |
| 1) Common Rail | 2) Capteur d'eau | 3) Élément filtrant |
| 1) Common Rail | 2) Sensore acqua | 3) Elemento filtrante |
| 1) Common Rail | 2) Sensor de agua | 3) Elemento filtrante |
| 1) Common Rail | 2) Wassersensor | 3) Filterelement |
| 1) Common Rail | 2) Vattensensor | 3) Filterelement |
| 1) Common Rail | 2) Čidlo vody | 3) Element filtru |
| 1) Common Rail | 2) Czujnik wody | 3) Element filtrujący |
| 1) Common Rail | 2) Датчик воды | 3) Фильтрующий элемент |

de

Jetronicfilter
für Einspritzanlagen

en

Jetronic filters for
fuel-injection systems

fr

Filtres Jetronic
pour systèmes d'injection

it

Filtri Jetronic per
impianti d'inezione

es

Filtros Jetronic para
sistemas de Inyección



Fig.

H
mmØ
mm

A ↓







A ↑

B ↓
mmB ↑
mm

0 450 ...

0 450 901 005	**		90	45				
0 450 902 151	16	0,2	127	56			8	8
0 450 902 161	16	0,2	143	62			8	8
0 450 902 162	9	0,2	95	133			8	8
0 450 904 058	17	0,1	105	35			8	8
0 450 904 163	18		134	42			7	7
0 450 905 002	22	0,2	140	59			8	8
0 450 905 005	21	0,2	130	62	M 14 x 1,5	M 12 x 1,5		
0 450 905 016	21	0,1	171	62			7,2	7,2
0 450 905 021	21	0,2	136	64	M 14 x 1,5	M 12 x 1,5		
0 450 905 030	22	0,4	158	81			8	8
0 450 905 066	21	0,6	173	81	M 14 x 1,5	M 14 x 1,5		
0 450 905 087	21	0,3	129	81	M 12 x 1,5	M 14 x 1,5		
0 450 905 091	21	0,6	172	88	M 12 x 1,5	M 14 x 1,5		
0 450 905 095	26	0,3	158	81			8	8
0 450 905 104	21	0,4	129	81	M 12 x 1,5	M 14 x 1,5		
0 450 905 133	21	0,6	172	89	M 12 x 1,5	M 14 x 1,5		
0 450 905 139	**	0,6	130	64	M 12 x 1,5	M 14 x 1,5		
0 450 905 143	21	0,6	169	85	M 14 x 1,5	M 14 x 1,5		
0 450 905 145	21	0,6	152	88	M 14 x 1,5	M 12 x 1,5		
0 450 905 177	21	0,6	169	86	M 12 x 1,5	M 14 x 1,5		
0 450 905 200	21	0,6	152	81	M 14 x 1,5	M 12 x 1,5		
0 450 905 201	22	0,4	151	74			9	9
0 450 905 203	21	0,4	148	80	M 12 x 1,5	M 14 x 1,5		
0 450 905 215	13		135	62				
0 450 905 216	22	0,6	195	88			8	8
0 450 905 219	**							
0 450 905 264	22	0,4	164	81			8	8
0 450 905 273	22	0,2	162	60			8	8
0 450 905 275	22	0,4	151	75			8	8
0 450 905 280	22	0,2	140	56			8	8
0 450 905 281	21	0,7	165	80	M 14 x 1,5	M 14 x 1,5		
0 450 905 287*	22	0,2	137	61			8	8
0 450 905 316	22	0,2	156	55			8	8
0 450 905 318	22	0,4	174	81			8	8
0 450 905 320	16	0,4	162	60			8	8
0 450 905 324	35	0,3	138	81			8	
0 450 905 326	35	0,2	121	62			8	8
0 450 905 401	21	0,4	129	81	M 14 x 1,5	M 12 x 1,5		
0 450 905 601	21	0,6	152	88	M 14 x 1,5	M 12 x 1,5		
0 450 905 901	22	0,4	203	55			8	8
0 450 905 903	22	0,8	158	81			8	8
0 450 905 904	22	0,3	128	62			8	8

nl	sv	cs	pl	ru
Jetronicfilters voor injectie-systemen	Jetronic-filter för insprutningsanläggningar	Filtr Jetronic pro vstřikovací soustavy	Filtr Jetronic do układów wtryskowych	Фильтры для систем впрыска Jetronic

	Fig.		$\frac{H}{\text{mm}}$	\varnothing mm	A 	A 	B \varnothing 	B \varnothing 
0 450 905 905	22	0,7	300	55			8	8
0 450 905 906	21	0,4	126	75	M 14 x 1,5	M 12 x 1,5		
0 450 905 908	16	0,6	210	88			8	8
0 450 905 909	36	0,2	94	86	M 14 x 1,5	M 14 x 1,25		
0 450 905 911	21	0,2	114	56	M 14 x 1,5	M 14 x 1,5		
0 450 905 912	21	0,2	116	70	M 14 x 1,5	M 14 x 1,5		
0 450 905 914	24	0,4	123	70	M 14 x 1,5	M 14 x 1,25		
0 450 905 915	24	0,2	109	70	M 14 x 1,5	M 12 x 1,2		
0 450 905 916	24	0,4	111	75	M 14 x 1,5	M 12 x 1,25		
0 450 905 920	24	0,2	111	75			9	9
0 450 905 922	20	0,4	68	50			9	9
0 450 905 923	33	0,1	58	49			8,5	8,5
0 450 905 924	24	0,1	104	65	M 14 x 1,5	M 12 x 1,25		
0 450 905 925	38	0,1	152	62			8	8
0 450 905 926	17	0,2	205	50			8	8
0 450 905 927	35	0,2	165	75			8	8
0 450 905 928	17	0,1	125	65			8	8
0 450 905 929	24	0,2	113	70	M 12 x 1,25	M 12 x 1,25		
0 450 905 939	35	0,2	180	56			8	8
0 450 905 940	35	0,2	167	75			8	8
0 450 905 942	22	0,4	340	56			8	8
0 450 905 943	40	0,2	170	88	M 12 x 1,25	M 12 x 1,25		
0 450 905 944	**	0,2	172	50			9,5	9,5
0 450 905 950	41	0,6	324	56	M 12 x 1,5	M 12 x 1,5	8	
0 450 905 951	42		152	65	M 14 x 1,5			8
0 450 905 952	43		159	86			8	8
0 450 905 953	41		123	65	M 14 x 1,5	M 14 x 1,5	8	
0 450 905 954	**		105	70			8	8
0 450 905 955	24		122	70	M 14 x 1,5	M 12 x 1,25		
0 450 905 956	24		155	70			8	8
0 450 905 957	24		175	70			8	8
0 450 905 958	17		159	65			8	8
0 450 905 959	**		165	62			8	8
0 450 905 960	43		310	75			8	8
0 450 905 961	**		330	62	M 12 x 1,5	M 12 x 1,5	8	

Gewindeanschluss
Threaded connection
Orifice taraudé
Raccordo filettato
Rosca de conexión
Schroefdraadaansluiting
Gånganslutning
Závitové připojení
Przyłącze gwintowane
Резьбовое соединение

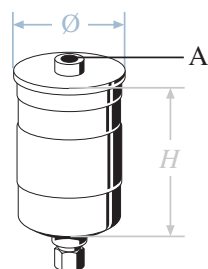

Schlauchanschluss
Hose connection
Raccord de flexible
Raccordo per tubazione
Racor para tubo flexible
Slangaansluiting
Slanganslutning
Hadicové připojení
Przyłącze wężyka
Подсоединение шланга

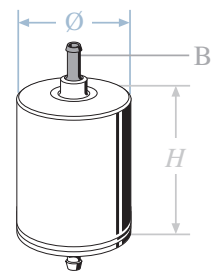

* Neu / New / Nouveau / Nuovo / Nuevo / Nieuwe / Ny / Nové / Nowe / Новые

** siehe Online-Katalog / see online catalog / voir le catalogue en ligne / vedi catalogo online / Ver catálogo online / zie online catalogus / se onlinekatalog / viz katalog online / zobacz katalog online / см. онлайн-каталог

de

**Jetronicfilter
für Einspritzanlagen**
(Fortsetzung)

en

**Jetronic filters for
fuel-injection systems**
(continued)

fr

**Filtres Jetronic
pour systèmes d'injection**
(suite)







it

**Filtri Jetronic per
impianti d'inezione**
(seguito)

es

**Filtros Jetronic para
sistemas de Inyección**
(continuación)



		Fig.		$\frac{H}{\text{mm}}$	$\frac{\varnothing}{\text{mm}}$	A 	A 	B $\frac{\varnothing}{\text{mm}}$ 	B $\frac{\varnothing}{\text{mm}}$ 
0 450 905 962	24			154	70	M 12 x 1,25	M 12 x 1,25	8	
0 450 905 963	24			109	64				
0 450 905 964	21			155	88	M 14 x 1,5	M 12 x 1,5		
0 450 905 966	35			145	82			8	8
0 450 905 967	24			162	70			8	8
0 450 905 968	**			157	75			8	8
0 450 905 969	35			160	59			8	8
0 450 905 970	**			185	70			8	8
0 450 905 971	**			150	70			8	8
0 450 905 972	24			130	70	M 12 x 1,25	M 12 x 1,25		
0 450 905 973	**			162	70			8	8
0 450 905 974	17			129	65			8	8
0 450 905 975	35			155	55			8	8
0 450 905 976	35			145	59			8	8
0 450 905 977	**			131	70	M 12 x 1,25			8
0 450 905 978	42			152	65	M 14 x 1,5			8
0 450 905 979	**			149	54			9,5	
0 450 905 980	41			173	70	M 14 x 1,5			
0 450 905 981	**			125	70	M 14 x 1,5	M 12 x 1,25		
0 450 905 982	**			150	82			8	8
0 450 905 983	35			135	70			8	8
0 450 905 984	**			130	70	M 12 x 1,25	M 12 x 1,25		
0 450 905 985	22			151	73			9,5	8
0 450 905 986	**			136	70			8	8
0 450 905 987	42			173	70	M 14 x 1,5			8
0 450 905 988	**			122	78	M 14 x 1,5			8
0 450 905 989	24			175	70			8	8
0 450 905 990	**			104	65	M 14 x 1,5	M 12 x 1,25		
0 450 915 001	10	0,1		131	75			8	8
0 450 915 003	**	0,3		160	75			8	8
0 986 ...									
0 986 450 100	40	0,4		95	86	M 12 x 1,5	M 12 x 1,5		
0 986 450 102	24	0,4		179	70			8	8
0 986 450 103	24	0,4		123	70	M 14 x 1,5	M 12 x 1,5		
0 986 450 104	40	0,4		94	86	M 14 x 1,5	M 12 x 1,5		
0 986 450 105	24	0,4		131	70			8	8
0 986 450 106	24	0,4		135	70			8	8
0 986 450 107	24	0,4		123	70	M 14 x 1,5	M 12 x 1,25		
0 986 450 108	24	0,4		175	70			8	8
0 986 450 109	24	0,4		130	70	M 12 x 1,5	M 12 x 1,5		
0 986 450 110	39	0,4		122	70	M 14 x 1,5	M 12 x 1,5		
0 986 450 111	24	0,4		123	70	M 14 x 1,5	M 12 x 1,5		
0 986 450 113	24	0,4		123	70	M 14 x 1,5	M 12 x 1,25		
0 986 450 114	44	0,5		120	85			8	8

nl

**Jetronicfilters voor
injectie-systemen**
(vervolg)

sv

**Jetronic-filter för
insprutningsanläggningar**
(fortsättning)

cs







**Filtr Jetronic pro
vstříkovací soustavy**
(pokračování)

pl

**Filtr Jetronic do układów
wtryskowych**
(ciąg dalszy)

ru

**Фильтры для систем
впрыска Jetronic**
(продолжение)

	Fig.		$\frac{H}{\text{mm}}$	\varnothing mm	A 	A 	B \varnothing mm 	B \varnothing mm 
0 986 450 115	24	0,4	122	70	M 14 x 1,5	M 12 x 1,25		
0 986 450 117	33	0,2	63	80			8	8
0 986 450 119	24	0,2	114	56	M 16 x 1,5	M 16 x 1,5		
0 986 450 120	24	0,2	109	55	M 12 x 1,25	M 12 x 1,25		
0 986 450 121	24	0,4	132	55			8	8
0 986 450 123	24	0,2	123	70	M 14 x 1,5	M 12 x 1,25		
0 986 450 124	39	0,2	113	56	M 14 x 1,5	M 14 x 1,5		
0 986 450 137	32	0,1	96	58			8	8
0 986 450 138	31	0,3	86	71			8	8
0 986 450 143	**							
0 986 450 212	31	0,2	108	57			7	8
0 986 450 220	22	0,1	175	58			9,5	9,5
0 986 450 221	24	0,3	123	70	M 14 x 1,5	M 14 x 1,25		
0 986 450 222	24	0,2	151	70			8	8
0 986 450 225	24	0,2	122	70	M 14 x 1,5	M 14 x 1,5		
0 986 450 226	24	0,2	101	86			8	8
0 986 450 510	37	0,2	135	70			8	8
0 986 450 604	24	0,2	122	70	M 14 x 1,5	M 12 x 1,25		
0 986 450 614	**							
0 986 450 624	24	0,2	123	70	M 14 x 1,5	M 12 x 1,25		

F 026 ...

F 026 402 115*	**		76,5	84				
F 026 403 000	**		207	70				
F 026 403 001	**		123	76				
F 026 403 002	35		143	55				
F 026 403 003	**		177	75				
F 026 403 006	**		165	62				
F 026 403 008	**		165	62				
F 026 403 009	35		182	55				

Gewindeanschluss
Threaded connection
Orifice taraudé
Raccordo filettato
Rosca de conexión
Schroefdraadaansluiting
Gånganslutning
Závitové připojení
Przyłącze gwintowane
Резьбовое соединение

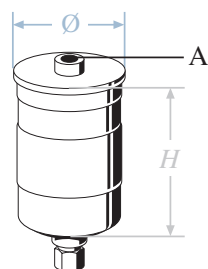

Schlauchanschluss
Hose connection
Raccord de flexible
Raccordo per tubazione
Racor para tubo flexible
Slangaansluiting
Slanganslutning
Hadicové připojení
Przyłącze wężyka
Подсоединение шланга

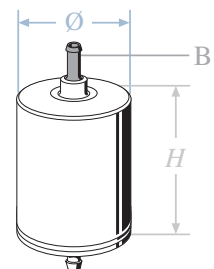

* Neu / New / Nouveau / Nuovo / Nuevo / Nieuwe / Ny / Nové / Nowe / Новые

** siehe Online-Katalog / see online catalog / voir le catalogue en ligne / vedi catalogo online / Ver catálogo online / zie online catalogus / se onlinekatalog / viz katalog online / zobacz katalog online / см. онлайн-каталог

de

Jetronicfilter für Einspritzanlagen
(Fortsetzung)

nl

Jetronicfilters voor injectie-systemen
(vervolg)

en

Jetronic filters for fuel-injection systems
(continued)

sv

Jetronic-filter för insprutningsanläggningar
(fortsättning)

fr

Filtres Jetronic pour systèmes d'injection
(suite)

cs

Filtr Jetronic pro vstřikovací soustavy
(pokračování)

it

Filtri Jetronic per impianti d'inezione
(seguito)

pl

Filtr Jetronic do układów wtryskowych
(ciąg dalszy)

es

Filtros Jetronic para sistemas de Inyección
(continuación)

ru

Фильтры для систем впрыска Jetronic
(продолжение)



Fig.



$\frac{H}{\text{mm}}$

$\frac{\varnothing}{\text{mm}}$

A ↓

A ↑

B ↓ $\frac{\varnothing}{\text{mm}}$

B ↑ $\frac{\varnothing}{\text{mm}}$

F 026 403 012 **		176	83				9,9	7,9
F 026 403 013 **		165	62					
F 026 403 015 **		143	70			M 14 x 1,5	8	
F 026 403 016 **		183	74					
F 026 403 019 * **		130	70		M 12 x 1,25	M 12 x 1,25		
F 026 403 020 * **		100	74,5					
F 026 403 021 * **		84	56,5					
F 026 403 754 * **		249,5	55					
F 026 403 755 * **		152	70					
F 026 403 757 * **		120	70					
F 026 403 758 * **		84	56,5					

Gewindeanschluss
Threaded connection
Orifice taraudé
Raccordo filettato
Rosca de conexión
Schroefdraadaansluiting
Gånganslutning
Závitové připojení
Przyłącze gwintowane
Резьбовое соединение

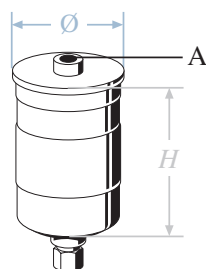

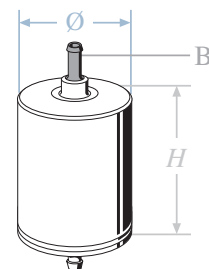

Schlauchanschluss
Hose connection
Raccord de flexible
Raccordo per tubazione
Racor para tubo flexible
Slangaansluiting
Slanganslutning
Hadicové připojení
Przyłącze wężyka
Подсоединение шланга





* Neu / New / Nouveau / Nuovo / Nuevo / Nieuwe / Ny / Nové / Nowe / Новые

** siehe Online-Katalog / see online catalog / voir le catalogue en ligne / vedi catalogo online / Ver catálogo online / zie online catalogus / se onlinekatalog / viz katalog online / zobacz katalog online / см. онлайн-каталог

de Innenraumfilter - Standard	en Cabin filter - Standard	fr Filtres d'habitacle - Standard	it Filtri abitacolo - Standard	es Filtros para el habitáculo - Estándar
nl Standaard interieurfilters	sv Kupéfilter - standard	cs Filtr vnitřního prostoru - standardní	pl Filtr wnętrza pojazdu - standard	ru Фильтр салона - стандарт

	Fig.	$a \times b \times c$		 №
		$H \times \varnothing$ mm		
1 987 431 154	85	385x128x40	M 1154	
1 987 431 155	85	438x181x56	M 1155	
1 987 431 156	85	571x158x47	M 1156	
1 987 431 157	85	571x158x37	M 1157	
1 987 431 159	85	269x188x36	M 1159	
1 987 431 162	85	361x159x40	M 1162	
1 987 431 163	85	466x182x70	M 1163	
1 987 431 164	85	417x156x25	M 1164	
1 987 431 165	85	440x99x38	M 1165	
1 987 431 166	85	450x206x25	M 1166	
1 987 431 167	97	210x210x50	M 1167	
1 987 431 168	85	439x181x32	M 1168	
1 987 431 169	85	250x150x45	M 1169	
1 987 431 170	**	205x92x19	M 1170	
1 987 431 171	**	293x118x21	M 1171	
1 987 431 172	100	199x178x17	M 1172	
1 987 431 174	85	324x162x27	M 1174	
1 987 431 175	**	326x163x29	M 1175	
1 987 431 176*	**	286x100x20	M 1176	
1 987 431 178*	**	84x181	M 1178	
1 987 431 181*	**	494x226x44	M 1181	
1 987 431 187*	**	450x150x30	M 1187	
1 987 431 189*	**	500x230x50	M 1189	
1 987 431 191*	**	261x161x38	M 1191	
1 987 431 204*	**	450x239x30	M 1204	
1 987 431 206*	**	846x248x20	M 1206	
1 987 431 210*	**	400x132x20	M 1210	
1 987 431 223	**	307x108x30	M 1223	
1 987 431 224	**	390x125x30	M 1224	
1 987 431 229*	**	422x194x30	M 1229	
1 987 432 001	84	209x202x54	M 2001	
1 987 432 002	85	296x159x26	M 2002	
1 987 432 003	85	290x160x30	M 2003	
1 987 432 004*	85	240x204x35	M 2004	
1 987 432 005	85	288x225x13	M 2005	
1 987 432 006	85	344x150x30	M 2006	
1 987 432 007	85	316x156x34	M 2007	
1 987 432 009	85	280x173x18	M 2009	
1 987 432 010	85	411x145x18	M 2010	
1 987 432 011	97	184x170x42	M 2011	
1 987 432 012	85	279x206x25	M 2012	
1 987 432 013	85	261x181x30	M 2013	
1 987 432 014	85	384x170x17	M 2014	
1 987 432 015	85	330x186x18	M 2015	
1 987 432 016	85	290x226x18	M 2016	

	Fig.	$a \times b \times c$		 №
		$H \times \varnothing$ mm		
1 987 432 017	85	387x147x33	M 2017	
1 987 432 018	85	505x108x32	M 2018	
1 987 432 019	85	309x140x16	M 2019	
1 987 432 020	85	255x122x40	M 2020	
1 987 432 021	85	218x211x19	M 2021	
1 987 432 022	85	271x189x29	M 2022	
1 987 432 024	85	312x193x36	M 2024	
1 987 432 026	85	210x211x30	M 2026	
1 987 432 027	87	240x181x19	M 2027	
1 987 432 028	85	536x110x25	M 2028	
1 987 432 030	85	413x146x25	M 2030	
1 987 432 032	85	327x163x28	M 2032	
1 987 432 033	85	346x214x20	M 2033	
1 987 432 034	85	203x178x40	M 2034	
1 987 432 036	85	661x95x20	M 2036	
1 987 432 037	85	354x244x30	M 2037	
1 987 432 038	85	258x233x30	M 2038	
1 987 432 039	85	231x160x30	M 2039	
1 987 432 040	85	292x199x30	M 2040	
1 987 432 041	**	323x102x30	M 2041	
1 987 432 042	85	438x144x18	M 2042	
1 987 432 043	85	366x161x29	M 2043	
1 987 432 044	85	366x210x28	M 2044	
1 987 432 045	85	350x160x30	M 2045	
1 987 432 048	87	337x157x30	M 2048	
1 987 432 049	85	184x181x30	M 2049	
1 987 432 050	87	229x174x19	M 2050	
1 987 432 051	85	372x73x24	M 2051	
1 987 432 052	85	230x110x60	M 2052	
1 987 432 053	85	222x199x30	M 2053	
1 987 432 055	85	250x172x20	M 2055	
1 987 432 056	88	102x168	M 2056	
1 987 432 057	85	252x216x32	M 2057	
1 987 432 058	85	250x193x20	M 2058	
1 987 432 059	85	265x160x30	M 2059	

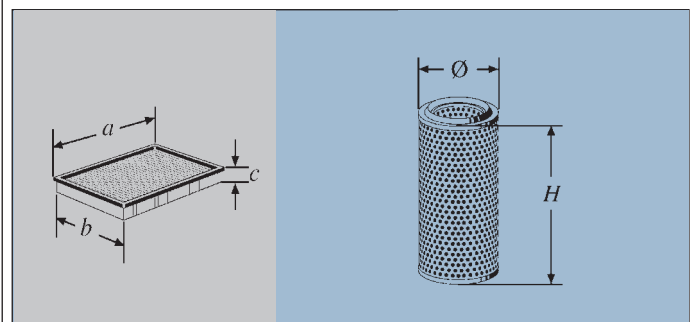

* Neu / New / Nouveau / Nuovo / Nuevo / Nieuwe / Ny / Nové / Nowe / Новые

** siehe Online-Katalog / see online catalog / voir le catalogue en ligne / vedi catalogo online / Ver catálogo online / zie online catalogus / se onlinekatalog / viz katalog online / zobacz katalog online / см. онлайн-каталог

de

**Innenraumfilter -
Standard**
(Fortsetzung)

en

**Cabin filter -
Standard**
(continued)

fr

**Filtres d'habitacle -
Standard**
(suite)

it

**Filtri abitacolo -
Standard**
(seguito)

es

**Filtros para el habitáculo -
Estándar**
(continuación)

	Fig.	a x b x c		Nº
		H x Ø		
mm				
1 987 432 060	85	193x86x34		M 2060
1 987 432 061	85	238x169x17		M 2061
1 987 432 062	85	253x160x30		M 2062
1 987 432 063	85	220x202x21		M 2063
1 987 432 064	85	270x240x25		M 2064
1 987 432 065	85	250x235x25		M 2065
1 987 432 066	85	230x191x17		M 2066
1 987 432 068	85	233x247x32		M 2068
1 987 432 069	85	228x195x30		M 2069
1 987 432 070	87	332x189x25		M 2070
1 987 432 071	85	300x205x30		M 2071
1 987 432 072	85	216x163x25		M 2072
1 987 432 073	85	509x101x35		M 2073
1 987 432 075	85	221x201x30		M 2075
1 987 432 076	85	331x165x30		M 2076
1 987 432 077	85	267x198x21		M 2077
1 987 432 078	85	240x108x20		M 2078
1 987 432 079	85	285x175x36		M 2079
1 987 432 080	**	210x208x30		M 2080
1 987 432 081	87	310x258x34		M 2081
1 987 432 082	85	460x118x30		M 2082
1 987 432 083	85	220x224x33		M 2083
1 987 432 084	85	206x186x17		M 2084
1 987 432 085	85	206x206x17		M 2085
1 987 432 086	92	228x37x13		M 2086
1 987 432 087	85	240x190x34		M 2087
1 987 432 088	85	219x200x20		M 2088
1 987 432 089	85	218x249x19		M 2089
1 987 432 090	85	234x223x18		M 2090
1 987 432 091	85	404x165x32		M 2091
1 987 432 092	85	196x216x25		M 2092
1 987 432 093	85	249x181x36		M 2093
1 987 432 094	86	239x238x47		M 2094
1 987 432 095	85	265x119x30		M 2095
1 987 432 096	85	441x126x30		M 2096
1 987 432 097	87	211x272x33		M 2097
1 987 432 100	**	382x154x50		M 2100
1 987 432 102	85	316x170x30		M 2102
1 987 432 103	85	314x164x30		M 2103
1 987 432 104	89	73x164		M 2104
1 987 432 105	87	215x187x25		M 2105
1 987 432 106	85	203x178x17		M 2106
1 987 432 107	85	230x213x12		M 2107
1 987 432 108	90	230x170x4		M 2108
1 987 432 109	**	245x210x35		M 2109

	Fig.	a x b x c		Nº
		H x Ø		
mm				
1 987 432 111	85	210x240x32		M 2111
1 987 432 112*	**	315x152x40		M 2112
1 987 432 113	85	235x209x35		M 2113
1 987 432 114	85	278x219x30		M 2114
1 987 432 115	86	178x183x28		M 2115
1 987 432 116	86	244x219x33		M 2116
1 987 432 117	91	198x108x22		M 2117
1 987 432 118	92	244x102x12		M 2118
1 987 432 119	86	242x205x21		M 2119
1 987 432 120	86	226x189x43		M 2120
1 987 432 121	85	222x198x30		M 2121
1 987 432 122	85	307x100x30		M 2122
1 987 432 124	100	810x123x20		M 2124
1 987 432 132	**	287x81x19		M 2132
1 987 432 133	**	214x200x30		M 2133
1 987 432 136	85	201x157x30		M 2136
1 987 432 137	85	290x96x30		M 2137
1 987 432 148	**	193x163x20		M 2148
1 987 432 150	85	380x134x37		M 2150
1 987 432 151	85	396x182x40		M 2151
1 987 432 152	85	311x225x25		M 2152
1 987 432 153	85	165x223x68		M 2153
1 987 432 154	**	120x114x10		M 2154
1 987 432 155	93	197x200x20		M 2155
1 987 432 156	85	213x108x17		M 2156
1 987 432 157	92	187x156x42		M 2157
1 987 432 158	**	227x263x34		M 2158
1 987 432 159	94	202x141x19		M 2159
1 987 432 160	95	248x97x38		M 2160
1 987 432 161	85	239x99x10		M 2161
1 987 432 162	95	178x72x24		M 2162
1 987 432 163	92	216x173x22		M 2163
1 987 432 164	94	175x174x12		M 2164
1 987 432 166	85	224x234x30		M 2166
1 987 432 167	85	181x93x29		M 2167
1 987 432 169	**	217x196x25		M 2169
1 987 432 170	85	227x201x17		M 2170
1 987 432 171	85	189x196x10		M 2171
1 987 432 172	85	199x178x17		M 2172
1 987 432 173	85	178x186x30		M 2173
1 987 432 175	99	259x200x25		M 2175
1 987 432 176	95	225x100x22		M 2176
1 987 432 177*	**	225x235x30		M 2177
1 987 432 179	92	222x102x12		M 2179

nl

Standaard
interieurfilters
(vervolg)

sv

Kupéfilter -
standard
(fortsättning)

cs



Filtr vnitřního prostoru -
standardní
(pokračování)



pl

Filtr wnętrza
pojazdu - standard
(ciąg dalszy)

ru

Фильтр салона -
стандарт
(продолжение)

	Fig.	$a \times b \times c$		 №
		$H \times \varnothing$		
mm				
1 987 432 182	92	386x248x30		M 2182
1 987 432 183	85	257x164x21		M 2183
1 987 432 184	85	224x114x30		M 2184
1 987 432 188	85	219x265x21		M 2188
1 987 432 189	92	214x163x43		M 2189
1 987 432 190	85	192x213x30		M 2190
1 987 432 192	86	355x129x25		M 2192
1 987 432 193	88	179x145		M 2193
1 987 432 194	85	260x100x25		M 2194
1 987 432 195	85	347x206x33		M 2195
1 987 432 197	**	230x160x30		M 2197
1 987 432 198	**	346x160x75		M 2198
1 987 432 200	85	315x153x34		M 2200
1 987 432 203	86	240x198x30		M 2203
1 987 432 204	85	238x197x20		M 2204
1 987 432 205	85	275x196x35		M 2205
1 987 432 206	85	376x176x48		M 2206
1 987 432 207	92	185x109x42		M 2207
1 987 432 208	92	330x192x45		M 2208
1 987 432 209	**	250x102x70		M 2209
1 987 432 210	**	273x187x62		M 2210
1 987 432 211	**	239x105x21		M 2211
1 987 432 213	85	354x235x34		M 2213
1 987 432 214	85	200x142x30		M 2214
1 987 432 215	85	236x191x22		M 2215
1 987 432 216	**	216x200x30		M 2216
1 987 432 218	85	219x154x20		M 2218
1 987 432 219	85	293x138x34		M 2219
1 987 432 220	**	240x190x34		M 2220
1 987 432 221	**	257x198x36		M 2221
1 987 432 222	**	275x202x27		M 2222
1 987 432 223	**	189x224x25		M 2223
1 987 432 224	**	189x238x19		M 2224
1 987 432 225	**	285x208x19		M 2225
1 987 432 226	**	228x235x19		M 2226
1 987 432 227	85	220x250x30		M 2227
1 987 432 228	**	200x176x30		M 2228
1 987 432 229	**	258x203x25		M 2229
1 987 432 230	85	252x154x36		M 2230
1 987 432 231	**	231x203x19		M 2231
1 987 432 234	**	205x211x30		M 2234
1 987 432 235	85	270x159x30		M 2235
1 987 432 236	85	200x270x20		M 2236
1 987 432 238	85	265x190x20		M 2238
1 987 432 239	**	275x89x30		M 2239

	Fig.	$a \times b \times c$		 №
		$H \times \varnothing$		
mm				
1 987 432 240	**	252x202x31		M 2240
1 987 432 241	**	247x198x19		M 2241
1 987 432 246*	**	210x225x20		M 2246
1 987 432 247*	**	242x152x30		M 2247
1 987 432 250*	**	216x200x30		M 2250
1 987 432 251*	**	230x200x26		M 2251
1 987 432 253*	**	230x180x20		M 2253
1 987 432 254*	**	236x211x17		M 2254
1 987 432 255*	**	236x184x28		M 2255
1 987 432 257*	**	200x215x30		M 2257
1 987 432 259*	**	244x84x26		M 2259
1 987 432 2	**	251x109x20		M 2260
1 987 432 262*	**	225x235x56		M 2262
1 987 432 263*	**	214x234x18		M 2263
1 987 432 267*	**	150x250x25		M 2267
1 987 432 269*	**	225x253x20		M 2269
1 987 432 272*	**	255x182x35		M 2272
1 987 432 273*	**	217x194x25		M 2273
1 987 432 274*	**	215x200x30		M 2274
1 987 432 275*	**	247x194x19		M 2275
1 987 432 277*	**	215x107x17		M 2277
1 987 432 278*	**	207x118x20		M 2278
1 987 432 281	87	310x257x35		M 2281
1 987 432 296	85	449x120x32		M 2296
1 987 432 299	85	214x214x25		M 2299
1 987 432 300	**	282x206x30		M 2300
1 987 432 377	**	232x179x21		M 2377
1 987 432 401	**	316x190x56		M 2401
1 987 432 431	**	275x219x30		M 2431

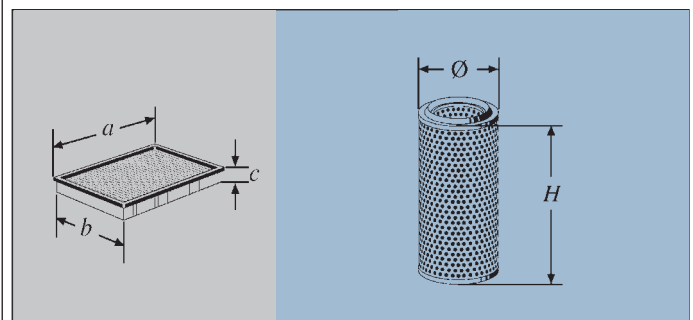

* Neu / New / Nouveau / Nuovo / Nuevo / Nieuwe / Ny / Nové / Nowe / Новые

** siehe Online-Katalog / see online catalog / voir le catalogue en ligne / vedi catalogo online / Ver catálogo online / zie online catalogus / se onlinekatalog / viz katalog online / zobacz katalog online / см. онлайн-каталог

de

Aktivkohle-
Innenraumfilter

en

Activated carbon
cabin filter

fr

Filtres d'habitacle
à charbon actif

it

Filtri abitacolo
ai carboni attivi

es

Filtros para el habitáculo
con carbón activo

Fig.

a x b x c

H x Ø

mm



Nº

1 987 ...

1 987 431 451	85	210x210x39	R 1451
1 987 431 452	85	263x152x45	R 1452
1 987 431 454	85	384x147x40	R 1454
1 987 431 455	103	418x147x37	R 1455
1 987 431 456	85	571x158x37	R 1456
1 987 431 457	85	439x181x32	R 1457
1 987 431 458	85	466x181x70	R 1458
1 987 432 222	**	275x202x27	M 2222
1 987 432 300	**	282x206x30	R 2300
1 987 432 301	**	259x203x54	R 2301
1 987 432 303	**	288x160x30	R 2303
1 987 432 304*	85	240x204x35	R 2304
1 987 432 306	**	344x150x30	R 2306
1 987 432 307	**	315x156x30	R 2307
1 987 432 309	85	254x134x41	R 2309
1 987 432 310	**	408x143x18	R 2310
1 987 432 311	85	270x196x32	R 2311
1 987 432 312	**	280x206x25	R 2312
1 987 432 313	**	258x181x30	R 2313
1 987 432 315	85	247x207x31	R 2315
1 987 432 317	**	378x147x27	R 2317
1 987 432 318	**	510x103x30	R 2318
1 987 432 319	85	230x215x30	R 2319
1 987 432 320	85	215x207x19	R 2320
1 987 432 324	**	310x194x30	R 2324
1 987 432 326	84	260x246x44	R 2326
1 987 432 327	**	257x157x35	R 2327
1 987 432 328	**	536x111x30	R 2328
1 987 432 330	**	412x146x25	R 2330
1 987 432 333	**	346x214x20	R 2333
1 987 432 336	**	661x95x20	R 2336
1 987 432 337	85	353x241x36	R 2337
1 987 432 343	**	366x157x27	R 2343
1 987 432 345	**	348x164x30	R 2345
1 987 432 348	87	337x158x30	R 2348
1 987 432 354	**	255x200x30	R 2354
1 987 432 357	**	246x216x32	R 2357
1 987 432 360	**	292x225x20	R 2360
1 987 432 361	**	262x198x32	R 2361
1 987 432 362	**	358x165x30	R 2362
1 987 432 363	**	215x231x20	R 2363
1 987 432 364	**	226x207x40	R 2364
1 987 432 365	**	222x207x30	R 2365



Fig.

a x b x c

H x Ø

mm



Nº

1 987 432 366	**	290x226x18	R 2366
1 987 432 367	87	280x203x28	R 2367
1 987 432 368	85	233x247x32	R 2368
1 987 432 369	87	279x241x35	R 2369
1 987 432 370	**	332x189x25	R 2370
1 987 432 371	**	300x205x30	R 2371
1 987 432 373	**	509x99x35	R 2373
1 987 432 376	**	331x165x30	R 2376
1 987 432 377	**	232x179x21	R 2377
1 987 432 378	**	198x202x40	R 2378
1 987 432 379	**	285x178x36	R 2379
1 987 432 380	**	210x208x30	R 2380
1 987 432 381	87	256x310x35	R 2381
1 987 432 382	**	460x118x30	R 2382
1 987 432 383	**	216x225x34	R 2383
1 987 432 386	**	174x138x30	R 2386
1 987 432 387	**	240x190x35	R 2387
1 987 432 389	**	259x231x19	R 2389
1 987 432 390	**	233x224x17	R 2390
1 987 432 392*	**	198x215x25	R 2392
1 987 432 393	92	270x182x42	R 2393
1 987 432 394	**	237x236x46	R 2394
1 987 432 397	99	211x272x33	R 2397
1 987 432 398	**	346x160x75	R 2398
1 987 432 399	**	503x141x38	R 2399
1 987 432 400	**	372x142x39	R 2400
1 987 432 401	86	316x190x56	R 2401
1 987 432 402	**	317x170x30	R 2402
1 987 432 405	85	272x196x32	R 2405
1 987 432 406	85	376x176x48	R 2406
1 987 432 407	85	327x165x34	R 2407
1 987 432 409	**	240x209x35	R 2409
1 987 432 410	**	394x184x32	R 2410
1 987 432 411	**	243x212x30	R 2411
1 987 432 412	**	315x150x40	R 2412
1 987 432 413	**	231x209x35	R 2413
1 987 432 415	85	236x190x22	R 2415
1 987 432 416	85	216x200x30	R 2416
1 987 432 419	97	303x138x34	R 2419
1 987 432 422	**	297x99x30	R 2422
1 987 432 423	98	406x213x58	R 2423
1 987 432 424	**	810x122x20	R 2424
1 987 432 425	**	530x239x30	R 2425
1 987 432 426	**	216x199x30	R 2426
1 987 432 428	85	259x183x45	R 2428

nl

Interieurfilters
met actieve koolstof

sv

Kupéfiter
med aktivt kol

cs

Filtr vnitřního prostoru
s aktivním uhlím

pl

Filtr wnętrza pojazdu
z węglem aktywnym

ru

Фильтр салона
с активированным углем



	Fig.	$a \times b \times c$	
		$H \times \varnothing$	 №
		mm	
1 987 432 431	85	275 x 219 x 30	R 2431
1 987 432 433	85	218 x 200 x 30	R 2433
1 987 432 434	85	203 x 178 x 40	R 2434
1 987 432 435	85	165 x 216 x 40	R 2435
1 987 432 436	**	205 x 159 x 32	R 2436
1 987 432 437	85	290 x 96 x 30	R 2437
1 987 432 438	85	263 x 184 x 31	R 2438
1 987 432 464	**	273 x 242 x 43	R 2464
1 987 432 468	85	214 x 227 x 17	R 2468
1 987 432 469	**	230 x 194 x 30	R 2469
1 987 432 482	85	398 x 275 x 33	R 2482
1 987 432 488	85	264 x 218 x 20	R 2488
1 987 432 495	85	347 x 208 x 33	R 2495
1 987 432 497	85	310 x 236 x 23	R 2497
1 987 432 498	92	216 x 241 x 45	R 2498
1 987 432 499	85	214 x 214 x 26	R 2499
1 987 432 500	85	266 x 133 x 30	R 2500
1 987 432 512	**	201 x 175 x 40	R 2512
1 987 432 513	85	356 x 236 x 35	R 2513
1 987 432 525	**	286 x 208 x 19	R 2525
1 987 432 531	**	279 x 248 x 39	R 2531
1 987 432 533	**	216 x 198 x 45	R 2533
1 987 432 535	**	269 x 157 x 30	R 2535
1 987 432 542*	**	187 x 188 x 25	R 2542
1 987 432 545*	**	215 x 250 x 530	R 2545
1 987 432 548*	**	253 x 256 x 34	R 2548
1 987 432 549*	**	270 x 188 x 35	R 2549
1 987 432 566*	**	179 x 178 x 20	R 2566
1 987 432 568*	**	192 x 197 x 30	R 2568
1 987 432 570	**	332 x 189 x 26	R 2570
1 987 432 571*	**	360 x 180 x 35	R 2571
1 987 432 574*	**	200 x 215 x 30	R 2574
1 987 432 597	**	211 x 272 x 34	R 2597
1 987 432 598*	**	247 x 203 x 36	R 2598



Fig.

 $a \times b \times c$ $H \times \varnothing$

mm



№

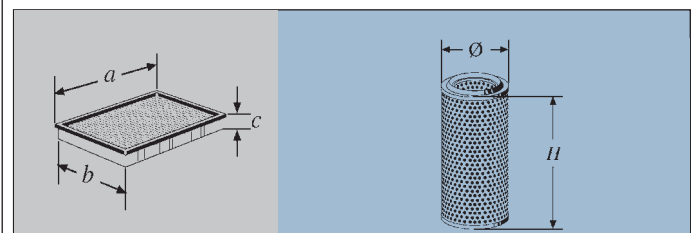

* Neu / New / Nouveau / Nuovo / Nuevo / Nieuwe / Ny / Nové / Nowe / Новые

** siehe Online-Katalog / see online catalog / voir le catalogue en ligne / vedi catalogo online / Ver catálogo online / zie online catalogus / se onlinekatalog / viz katalog online / zobacz katalog online / см. онлайн-каталог



0 451 102 056	0 451 103 901	AUSTIN, BEDFORD, BKS, FORD, INNOCENTI-LEYLAND, LEYLAND, LOTUS, MG, MINI, MORRIS, OPEL, PRINCESS, ROVER, STEYR, VAUXHALL
0 451 103 029	0 451 103 903	ALFA ROMEO, CHRYSLER, DAVID BROWN, FAUN, FORD, HILLMAN, LINDE, MERCURISER, O & K, RELIANT, SAAB, SEAT, STEINBOCK, STILL, SUNBEAM
0 451 103 033	0 451 103 904	AGRIA, ATLAS COPCO, AUDI, BOMAG, FLOTTMANN WERKE, FORD, JW, KHD, NISSAN, NSU, PORSCHE, REFORMWERKE BAUER, SEAT, SULLAIR, TRABANT, VW, WARTBURG
0 451 103 079	0 451 103 204	BUICK, CHEVROLET, DAEWOO, HOLDEN, NISSAN, OPEL, ROVER, SAAB, TOYOTA, VAUXHALL
0 451 103 219	0 451 103 221	ATLAS COPCO, OPEL, VOLVO
0 451 103 298	0 451 103 907	AUSTIN, FORD, MAZDA, ROVER, SKODA, STEINBOCK
0 451 203 012	0 451 103 906	AUDI, LINDE, NISSAN, SEAT, VOLVO, VW
0 451 103 261	F 026 408 900	CITROËN, FIAT, LANCIA, NISSAN, PEUGEOT, ROVER, SUZUKI
0 451 103 086	F 026 408 901	BMW
0 451 103 314	F 026 408 902	AUDI, SEAT, SKODA, VW
0 451 203 154	F 026 408 903	ABG, AHLMANN, AIFO, AKERMANS VERKSTAD AB, ATLAS, ATLAS COPCO, BAUER, BKS, BOMAG, CASE IH, CLAAS, CLARK, CLAYSON, COLES, DEMAG, DEUTZ-FAHR, DRESSER, EDER, FAHR, FAUN, FENDT, FIAT, FLOTTMANN WERKE, FRISCH, FUCHS, GOTTWALD, HAMM, HANOMAG, HATRA, HOES, HY-MAC, IH, INGERSOLL-RAND, IRMER U. ELZE, IVECO, JW, KAELEBLE, KAELEBLE-GMEINDER, KHD, KOCKUM, KRAMER, KÄSSBOHRER, LAMBORGHINI, LIEBHERR, LINDE, LMV, LOMBARDINI, LOSENHAUSEN, MAGIRUS-DEUTZ, MAN, MASSEY-FERGUSON-HANOMAG, MENCK U. HAMBROCK, MENGELE, MIAG, MWM-DIESEL, O & K, POCLAIN, RENAULT, RUTHEMEYER, SAURER, SCANIA, SCHOPF, SENNEBOGEN, SOYLAND, STEINBOCK, STILL, SULLAIR, VALMET, VOLVO, WELLER, WESERHÜTTE
0 451 104 066	F 026 408 904	ABG, AHLMANN, ATLAS, ATLAS COPCO, BAUER, BKS, BOMAG, CLAAS, CLARK, DEMAG, DEUTZ-FAHR, DYNAPAC, EDER, FAHR, FENDT, FLOTTMANN WERKE, FRISCH, FUCHS, HAMM, HANOMAG, HATRA, HOES, INGERSOLL-RAND, IRMER U. ELZE, IVECO, KAELEBLE, KHD, KRAMER, KÄSSBOHRER, LIEBHERR, LINDE, LOSENHAUSEN, MAGIRUS-DEUTZ, MASSEY-FERGUSON-HANOMAG, MIAG, MWM-DIESEL, O & K, POCLAIN, PORSCHE, RUTHEMEYER, SCHOPF, SENNEBOGEN, STEINBOCK, STILL, SULLAIR, VALMET, WELLER, WESERHÜTTE



nl

Filters-groot-
verpakkingen

sv

Filter-
Storförpackningar

cs

Velké balení
filtru

pl

Duże opakowania
filtrów

ru

Оптовые упаковки
фильтров



0 450 904 058

F 026 403 900

AUTOBIANCHI, BMW, CITROËN, DAEWOO, FIAT, FORD, HOLDEN, INNOCENTI,
LANCIA, MOSKWITSCH, NISSAN, PEUGEOT, RENAULT, TALBOT, TOYOTA, ZAZ



1 987 432 012

1 987 432 808

AUDI, SEAT, SKODA, VW



de

SB-Verpackung →
Werkstattverpackung

en

Self-service pack →
workshop packs

fr

Emballage libre-service →
emballage atelier

it

Confezione self-service →
confezione per officina

es

Envase de autoservicio →
envase de taller



0 450 906 383	FF 19	0 450 906 274
0 450 906 384	FF 21	0 450 906 374
1 457 030 814	FF 60	1 457 030 013
1 457 070 802	FF 61	1 457 070 000
1 457 429 279	FF 04	1 457 431 028

1 457 429 280	FF 05	1 457 429 289
1 457 429 281	FF 06	1 457 429 291
1 457 431 700	FF 15	1 457 429 657
1 457 431 701	FF 16	1 457 429 621
1 457 431 721	FF 20	1 457 429 656

1 457 431 726	FF 22	1 457 431 712
1 457 431 727	FF 23	1 457 431 703
1 457 434 177	FF 02	1 457 434 106
1 457 434 220	FF 03	1 457 434 200
1 457 434 221	FF 01	1 457 434 201

F 026 402 800	FF 100	1 457 070 008
F 026 402 801	FF 101	F 026 402 008
F 026 402 802	FF 102	1 457 434 440
F 026 402 803	FF 103	F 026 402 082
F 026 402 804	FF 104	F 026 402 081

F 026 402 805	FF 301	F 026 402 072
F 026 402 806	FF 302	F 026 402 061
F 026 402 807	FF 107	F 026 402 067
F 026 402 882	FF 62	1 457 431 705
F 026 402 887	FF 300	0 450 906 460

F 026 402 888	FF 304	0 450 906 468
F 026 402 889	FF 306	0 450 907 006
F 026 402 890	FF 90	0 450 902 161
F 026 402 891	FF 91	0 450 905 287
F 026 402 892	FF 303	0 450 906 461

F 026 402 893	FF 305	0 450 906 469
F 026 402 894	FF 307	0 450 906 473
F 026 402 895	FF 95	1 457 070 001
F 026 402 896	FF 96	1 457 431 723
F 026 402 897	FF 308	F 026 402 016

F 026 402 898	FF 98	1 457 434 321
F 026 402 899	FF 99	1 457 070 007



nl

Zelfbedieningsverpakking
→ werkplaatsverpakking

sv

SB-förpackning →
verkstadsförpackning

cs

Samoobslužné balení →
Servisní balení

pl

Opakowanie
samoobsługowe →
opakowanie warsztatowe

ru

Упаковка для
самообслуживания →
Упаковка для СТО

0 451 103 134	OF 11	0 451 103 033
0 451 103 241	OF 28	0 451 103 170
0 451 103 246	OF 30	0 451 103 240
0 451 103 247	OF 31	0 451 103 227
0 451 103 391	OF 77	0 451 103 355

0 451 104 505	OF 59	0 451 103 259
0 451 104 506	OF 42	0 451 103 261
0 451 104 508	OF 54	0 451 103 252
0 451 104 509	OF 41	0 451 103 292
0 451 104 521	OF 34	F 026 407 106

0 451 104 523	OF 66	0 451 103 298
0 451 104 525	OF 71	0 451 103 318
0 451 105 189	OF 08	0 451 103 336
1 457 429 111	OF 69	1 457 429 619
1 457 429 187	OF 75	1 457 437 002

1 457 429 250	OF 79	1 457 429 193
1 457 429 299	OF 81	1 457 429 249
F 026 408 809	OF 109	F 026 407 067
F 026 408 881	OF 84	F 026 407 015
F 026 408 882	OF 82	0 451 103 353

F 026 408 885	OF 85	0 451 103 370
F 026 408 886	OF 86	0 451 104 025
F 026 408 887	OF 87	1 457 429 238
F 026 408 888	OF 88	1 457 429 192
F 026 408 889	OF 89	F 026 407 022

F 026 408 890	OF 90	0 451 103 347
F 026 408 891	OF 91	1 457 429 184
F 026 408 892	OF 92	F 026 407 001
F 026 408 893	OF 93	F 026 407 006
F 026 408 894	OF 94	0 986 452 028

F 026 408 895	OF 95	0 986 452 041
F 026 408 896	OF 96	F 026 407 014
F 026 408 897	OF 97	1 457 429 199
F 026 408 898	OF 98	1 457 429 256
F 026 408 899	OF 99	1 457 429 301



de

Gegenüberstellung
Bestellnummer →
Suchnummer

en

Cross references
part number →
search number

fr

Table de correspon-
dance référence →
code d'identification

it

Confronto codice di
ordinazione → codice
breve

es

Confrontación refe-
rencia de pedido →
referencia comercial

0 450 ...

0 450 901 005	F 1005
0 450 902 151	F 2151
0 450 902 161	F 2161
0 450 902 162	F 2162
0 450 904 058	F 4058
0 450 904 060	N 4060
0 450 904 077	N 4077
0 450 904 149	F 4149
0 450 904 158	N 4158
0 450 904 159	F 4159
0 450 904 161	N 4161
0 450 904 162	F 4162
0 450 904 163	F 4163
0 450 905 002	F 5002
0 450 905 005	F 5005
0 450 905 016	F 5016
0 450 905 021	F 5021
0 450 905 030	F 5030
0 450 905 066	F 5066
0 450 905 087	F 5087
0 450 905 091	F 5091
0 450 905 095	F 5095
0 450 905 104	F 5104
0 450 905 133	F 5133
0 450 905 139	F 5139
0 450 905 143	F 5143
0 450 905 145	F 5145
0 450 905 177	F 5177
0 450 905 200	F 5200
0 450 905 203	F 5203
0 450 905 215	F 5215
0 450 905 216	F 5216
0 450 905 219	F 5219
0 450 905 264	F 5264
0 450 905 273	F 5273
0 450 905 280	F 5280
0 450 905 281	F 5281
0 450 905 287	F 5287
0 450 905 316	F 5316
0 450 905 318	F 5318
0 450 905 320	F 5320
0 450 905 324	F 5324
0 450 905 326	F 5326

0 450 905 401	F 5401
0 450 905 601	F 5601
0 450 905 901	F 5901
0 450 905 903	F 5903
0 450 905 904	F 5904
0 450 905 906	F 5906
0 450 905 908	F 5908
0 450 905 909	F 5909
0 450 905 911	F 5911
0 450 905 912	F 5912
0 450 905 914	F 5914
0 450 905 915	F 5915
0 450 905 916	F 5916
0 450 905 920	F 5920
0 450 905 921	F 5921
0 450 905 922	F 5922
0 450 905 923	F 5923
0 450 905 924	F 5924
0 450 905 925	F 5925
0 450 905 926	F 5926
0 450 905 927	F 5927
0 450 905 928	F 5928
0 450 905 929	F 5929
0 450 905 930	N 5930
0 450 905 939	F 5939
0 450 905 940	F 5940
0 450 905 942	N 5942
0 450 905 943	F 5943
0 450 905 944	F 5944
0 450 905 950	F 5950
0 450 905 951	F 5951
0 450 905 952	F 5952
0 450 905 953	F 5953
0 450 905 954	F 5954
0 450 905 955	F 5955
0 450 905 956	F 5956
0 450 905 957	F 5957
0 450 905 958	F 5958
0 450 905 959	F 5959
0 450 905 960	F 5960
0 450 905 961	F 5961
0 450 905 962	F 5962
0 450 905 963	F 5963
0 450 905 964	F 5964
0 450 905 966	F 5966

0 450 905 967	F 5967
0 450 905 968	F 5968
0 450 905 969	F 5969
0 450 905 971	F 5971
0 450 905 972	F 5972
0 450 905 973	F 5973
0 450 905 974	F 5974
0 450 905 975	F 5975
0 450 905 976	F 5976
0 450 905 977	F 5977
0 450 905 978	F 5978
0 450 905 979	F 5979
0 450 905 980	F 5980
0 450 905 981	F 5981
0 450 905 982	F 5982
0 450 905 983	F 5983
0 450 905 985	F 5985
0 450 905 986	F 5986
0 450 905 987	F 5987
0 450 905 988	F 5988
0 450 905 989	F 5989
0 450 905 990	F 5990
0 450 906 172	N 6172
0 450 906 174	N 6174
0 450 906 261	N 6261
0 450 906 267	N 6267
0 450 906 274	N 6274
0 450 906 281	N 6281
0 450 906 295	N 6295
0 450 906 308	N 6308
0 450 906 318	N 6318
0 450 906 322	N 6322
0 450 906 334	N 6334
0 450 906 357	N 6357
0 450 906 373	N 6373
0 450 906 374	N 6374
0 450 906 376	N 6376
0 450 906 406	N 6406
0 450 906 407	N 6407
0 450 906 409	N 6409
0 450 906 426	N 6426
0 450 906 429	N 6429
0 450 906 431	N 6431
0 450 906 437	N 6437
0 450 906 442	N 6442

0 450 906 450	N 6450
0 450 906 451	N 6451
0 450 906 452	N 6452
0 450 906 453	N 6453
0 450 906 457	N 6457
0 450 906 458	N 6458
0 450 906 459	N 6459
0 450 906 460	N 6460
0 450 906 461	N 6461
0 450 906 462	N 6462
0 450 906 463	N 6463
0 450 906 464	N 6464
0 450 906 467	N 6467
0 450 906 468	N 6468
0 450 906 469	N 6469
0 450 906 473	N 6473
0 450 906 500	N 6500
0 450 906 503	N 6503
0 450 906 508	N 6508
0 450 906 511	N 6511
0 450 907 006	N 7006
0 450 907 007	N 7007
0 450 907 008	N 7008
0 450 907 011	N 7011
0 450 907 016	N 7016
0 450 915 001	F 5001
0 450 915 003	F 5003/1
0 451 103 004	P 3004
0 451 103 028	P 3028
0 451 103 029	P 3029
0 451 103 038	P 3038
0 451 103 062	P 3062
0 451 103 109	P 3109
0 451 103 141	P 3141
0 451 103 144	P 3144
0 451 103 217	P 3217
0 451 103 221	P 3221
0 451 103 232	P 3232
0 451 103 240	P 3240
0 451 103 249	P 3249

0 451 ...

nl

Omzettingslijst
Bestelnummer →
Opzoeknummer

sv

Artikelnummer →
Söknummer

cs









Převod objednáací číslo →
vyhledávací číslo

pl

Zestawienie
numer katalogowy →
numer identyfikacyjny

ru

Соответствие Номер
артикула →
Поисковый номер

	 №		 №		 №		 №
0 451 103 252	P 3252	0 451 203 231	P 3231	0 986 450 220	F 0220	1 457 429 053	S 9053
0 451 103 253	P 3253	0 451 300 003	P 0003	0 986 450 221	F 0221	1 457 429 054	S 9054
0 451 103 257	P 3257	0 451 300 004	P 0004	0 986 450 222	F 0222	1 457 429 064	S 9064
0 451 103 258	P 3258	0 451 300 005	P 0005	0 986 450 225	F 0225	1 457 429 066	S 9066
0 451 103 260	P 3260	0 451 300 007	P 0007	0 986 450 226	F 0226	1 457 429 078	S 9078
0 451 103 270	P 3270	0 451 300 008	P 0008	0 986 450 508	N 0508	1 457 429 105	P 9105
0 451 103 275	P 3275	0 451 301 156	P 1156	0 986 450 509	N 0509	1 457 429 107	P 9107
0 451 103 276	P 3276	0 451 301 207	P 1207	0 986 450 510	F 0510	1 457 429 113	P 9113
0 451 103 289	P 3289	0 451 302 182	P 2182	0 986 450 604	F 0604	1 457 429 117	P 9117
0 451 103 290	P 3290	0 451 403 001	P 3001	0 986 450 614	F 0614	1 457 429 118	P 9118
0 451 103 297	P 3297	0 451 403 077	P 3077	0 986 450 624	F 0624	1 457 429 119	P 9119
0 451 103 311	P 3311	0 451 403 208	P 3208	0 986 452 000	P 2000	1 457 429 123	P 9123
0 451 103 316	P 3316	0 451 403 210	P 3210	0 986 452 005	P 2005	1 457 429 126	P 9126
0 451 103 330	P 3330			0 986 452 016	P 2016	1 457 429 128	P 9128
0 451 103 337	P 3337			0 986 452 019	P 2019	1 457 429 130	P 9130
0 451 103 341	P 3341	0 986 ...		0 986 452 020	P 2020	1 457 429 137	P 9137
0 451 103 343	P 3343	0 986 450 018	F 0018	0 986 452 023	P 2023	1 457 429 139	P 9139
0 451 103 346	P 3346	0 986 450 030	F 0030	0 986 452 024	P 2024	1 457 429 152	P 9152
0 451 103 347	P 3347	0 986 450 037	F 0037	0 986 452 028	P 2028	1 457 429 154	P 9154
0 451 103 357	P 3357	0 986 450 037	F 0037	0 986 452 030	P 2030	1 457 429 165	P 9165
0 451 103 360	P 3360	0 986 450 039	F 0039	0 986 452 035	P 2035	1 457 429 167	P 9167
0 451 103 365	P 3365	0 986 450 100	F 0100	0 986 452 042	P 2042	1 457 429 174	P 9174
0 451 103 366	P 3366	0 986 450 102	F 0102	0 986 452 044	P 2044	1 457 429 175	P 9175
0 451 103 368	P 3368	0 986 450 103	F 0103	0 986 452 046	P 2046	1 457 429 185	P 9185
0 451 104 005	P 4005	0 986 450 104	F 0104	0 986 452 058	P 2058	1 457 429 194	P 9194
0 451 104 010	P 4010	0 986 450 105	F 0105	0 986 452 060	P 2060	1 457 429 196	P 9196
0 451 104 013	P 4013	0 986 450 106	F 0106	0 986 452 061	P 2061	1 457 429 198	P 9198
0 451 104 015	P 4015	0 986 450 107	F 0107	0 986 452 062	P 2062	1 457 429 199	P 9199
0 451 104 065	P 4065	0 986 450 108	F 0108	0 986 452 063	P 2063	1 457 429 225	N 9225
0 451 104 066	P 4066	0 986 450 109	F 0109	0 986 452 064	P 2064	1 457 429 230	N 9230
0 451 104 067	P 4067	0 986 450 110	F 0110	0 986 452 066	P 2066	1 457 429 238	P 9238
0 451 105 067	P 5067	0 986 450 111	F 0111	0 986 452 400	P 2400	1 457 429 239	P 9239
0 451 105 188	P 5188	0 986 450 113	F 0113	0 986 626 789	S 6789	1 457 429 248	P 9248
0 451 203 002	P 3002	0 986 450 114	F 0114	0 986 626 791	S 6791	1 457 429 252	P 9252
0 451 203 005	P 3005	0 986 450 115	F 0115			1 457 429 267	P 9267
0 451 203 010	P 3010	0 986 450 117	F 0117	1 457 ...		1 457 429 270	P 9270
0 451 203 108	P 3108	0 986 450 119	F 0119	1 457 030 013	N 0013	1 457 429 271	P 9271
0 451 203 152	P 3152	0 986 450 120	F 0120	1 457 070 000	N 0000	1 457 429 272	P 9272
0 451 203 194	P 3194	0 986 450 121	F 0121	1 457 070 001	N 0001	1 457 429 274	P 9274
0 451 203 197	P 3197	0 986 450 123	F 0123			1 457 429 275	P 9275
0 451 203 201	P 3201	0 986 450 124	F 0124	1 457 070 007	N 0007	1 457 429 276	P 9276
0 451 203 220	P 3220	0 986 450 137	F 0137	1 457 070 008	N 0008	1 457 429 277	P 9277
0 451 203 223	P 3223	0 986 450 138	F 0138	1 457 070 010	N 0010	1 457 429 284	P 9284
0 451 203 227	P 3227/1	0 986 450 143	F 0143	1 457 429 030	S 9030	1 457 429 286	P 9286
0 451 203 228	P 3228/1	0 986 450 212	F 0212	1 457 429 050	S 9050	1 457 429 289	N 9289

de

Gegenüberstellung
Bestellnummer →
Suchnummer
(Fortsetzung)

en

Cross references
part number →
search number
(continued)

fr

Table de correspon-
dance référence →
code d'identification
(suite)

it

Confronto codice di
ordinazione → codice
breve
(seguito)

es

Confrontación refe-
rencia de pedido →
referencia comercial
(continuación)



1 457 429 291	N 9291
1 457 429 302	P 9302
1 457 429 307	P 9307
1 457 429 308	P 9308
1 457 429 354	N 9354

1 457 429 359	N 9359
1 457 429 416	P 9416
1 457 429 546	P 9546
1 457 429 559	P 9559
1 457 429 600	P 9600

1 457 429 619	P 9619
1 457 429 621	N 9621
1 457 429 629	P 9629
1 457 429 631	P 9631
1 457 429 636	P 9636

1 457 429 646	P 9646
1 457 429 647	P 9647
1 457 429 648	P 9648
1 457 429 649	P 9649
1 457 429 655	N 9655

1 457 429 656	N 9656
1 457 429 657	N 9657
1 457 429 675	N 9675
1 457 429 676	N 9676
1 457 429 681	N 9681

1 457 429 732	P 9732
1 457 429 735	P 9735
1 457 429 740	P 9740
1 457 429 775	S 9775
1 457 429 781	S 9781

1 457 429 789	S 9789
1 457 429 791	S 9791
1 457 429 792	S 9792
1 457 429 793	S 9793
1 457 429 794	S 9794

1 457 429 800	S 9800
1 457 429 801	S 9801
1 457 429 806	S 9806
1 457 429 810	S 9810
1 457 429 817	S 9817

1 457 429 819	S 9819
1 457 429 820	P 9820
1 457 429 821	S 9821
1 457 429 840	S 9840
1 457 429 842	S 9842



1 457 429 845	S 9845
1 457 429 846	S 9846
1 457 429 854	S 9854
1 457 429 871	S 9871
1 457 429 873	S 9873

1 457 429 874	S 9874
1 457 429 875	S 9875
1 457 429 876	S 9876
1 457 429 882	S 9882
1 457 429 886	S 9886

1 457 429 893	S 9893
1 457 429 894	S 9894
1 457 429 895	S 9895
1 457 429 899	S 9899
1 457 429 920	S 9920

1 457 429 932	S 9932
1 457 429 933	S 9933
1 457 429 934	S 9934
1 457 429 941	S 9941
1 457 429 942	S 9942

1 457 429 946	S 9946
1 457 429 950	S 9950
1 457 429 954	S 9954
1 457 429 959	S 9959
1 457 429 966	S 9966

1 457 429 969	S 9969
1 457 429 975	S 9975
1 457 429 979	S 9979
1 457 429 980	S 9980
1 457 429 983	S 9983

1 457 429 988	S 9988
1 457 429 991	S 9991
1 457 429 998	S 9998
1 457 431 028	N 1028
1 457 431 158	N 1158

1 457 431 159	N 1159
1 457 431 261	N 1261
1 457 431 270	N 1270
1 457 431 325	N 1325
1 457 431 326	N 1326

1 457 431 702	N 1702
1 457 431 703	N 1703
1 457 431 704	N 1704
1 457 431 705	N 1705
1 457 431 707	N 1707



1 457 431 708	N 1708
1 457 431 710	N 1710
1 457 431 712	N 1712
1 457 431 713	N 1713
1 457 431 718	N 1718

1 457 431 720	N 1720
1 457 431 723	N 1723
1 457 431 724	N 1724
1 457 431 729	N 1729
1 457 432 100	S 2100

1 457 432 106	S 2106
1 457 432 108	S 2108
1 457 432 110	S 2110
1 457 432 128	S 2128
1 457 432 138	S 2138

1 457 432 146	S 2146
1 457 432 149	S 2149
1 457 432 150	S 2150
1 457 432 185	S 2185
1 457 432 188	S 2188

1 457 432 192	S 2192
1 457 432 193	S 2193
1 457 432 208	S 2208
1 457 432 210	S 2210
1 457 433 003	S 3003

1 457 433 005	S 3005
1 457 433 006	S 3006
1 457 433 008	S 3008
1 457 433 036	S 3036
1 457 433 037	S 3037

1 457 433 042	S 3042
1 457 433 044	S 3044
1 457 433 045	S 3045
1 457 433 053	S 3053
1 457 433 056	S 3056

1 457 433 058	S 3058
1 457 433 060	S 3060
1 457 433 061	S 3061
1 457 433 062	S 3062
1 457 433 066	S 3066

1 457 433 069	S 3069
1 457 433 070	S 3070
1 457 433 073	S 3073
1 457 433 083	S 3083
1 457 433 086	S 3086



1 457 433 089	S 3089
1 457 433 096	S 3096
1 457 433 098	S 3098
1 457 433 099	S 3099
1 457 433 152	S 3152

1 457 433 153	S 3153
1 457 433 154	S 3154
1 457 433 155	S 3155
1 457 433 160	S 3160
1 457 433 161	S 3161

1 457 433 163	S 3163
1 457 433 164	S 3164
1 457 433 200	S 3200
1 457 433 201	S 3201
1 457 433 204	S 3204

1 457 433 231	S 3231
1 457 433 232	S 3232
1 457 433 234	S 3234
1 457 433 252	S 3252
1 457 433 256	S 3256

1 457 433 259	S 3259
1 457 433 264	S 3264
1 457 433 266	S 3266
1 457 433 269	S 3269
1 457 433 273	S 3273

1 457 433 275	S 3275
1 457 433 282	S 3282
1 457 433 285	S 3285
1 457 433 286	S 3286
1 457 433 290	S 3290

1 457 433 292	S 3292
1 457 433 294	S 3294
1 457 433 299	S 3299
1 457 433 303	S 3303
1 457 433 307	S 3307

1 457 433 308	S 3308
1 457 433 309	S 3309
1 457 433 314	S 3314
1 457 433 319	S 3319
1 457 433 322	S 3322

1 457 433 324	S 3324
1 457 433 326	S 3326
1 457 433 327	S 3327
1 457 433 330	S 3330
1 457 433 331	S 3331

nl

Omzettingslijst
Bestelnummer →
Opzoeknummer
 (vervolg)

sv

Artikelnummer →
Söknummer
 (fortsättning)

cs









Převod objednáací číslo →
vyhledávací číslo
 (pokračování)

pl

Zestawienie
numer katalogowy →
numer identyfikacyjny
 (ciąg dalszy)

ru

Соответствие Номер
артикула →
Поисковый номер
 (продолжение)

	 №		 №		 №		 №
1 457 433 332	S 3332	1 457 433 627	S 3627	1 457 433 901	S 3901	1 457 434 293	N 4293
1 457 433 333	S 3333	1 457 433 637	S 3637	1 457 433 903	S 3903	1 457 434 294	N 4294
1 457 433 334	S 3334	1 457 433 646	S 3646	1 457 433 904	S 3904	1 457 434 295	N 4295
1 457 433 336	S 3336	1 457 433 650	S 3650	1 457 433 952	S 3952	1 457 434 296	N 4296
1 457 433 337	S 3337	1 457 433 651	S 3651	1 457 433 953	S 3953	1 457 434 302	N 4302
1 457 433 338	S 3338	1 457 433 654	S 3654	1 457 433 954	S 3954	1 457 434 306	N 4306
1 457 433 339	S 3339	1 457 433 655	S 3655	1 457 433 955	S 3955	1 457 434 310	N 4310
1 457 433 521	S 3521	1 457 433 659	S 3659	1 457 433 956	S 3956	1 457 434 314	N 4314
1 457 433 531	S 3531	1 457 433 670	S 3670	1 457 433 957	S 3957	1 457 434 321	N 4321
1 457 433 532	S 3532	1 457 433 671	S 3671	1 457 433 958	S 3958	1 457 434 324	N 4324
1 457 433 533	S 3533	1 457 433 677	S 3677	1 457 433 959	S 3959	1 457 434 329	N 4329
1 457 433 534	S 3534	1 457 433 682	S 3682	1 457 433 961	S 3961	1 457 434 331	N 4331
1 457 433 535	S 3535	1 457 433 688	S 3688	1 457 433 962	S 3962	1 457 434 400	N 4400
1 457 433 538	S 3538	1 457 433 690	S 3690	1 457 433 963	S 3963	1 457 434 402	N 4402
1 457 433 539	S 3539	1 457 433 702	S 3702	1 457 433 965	S 3965	1 457 434 405	N 4405
1 457 433 541	S 3541	1 457 433 711	S 3711	1 457 433 966	S 3966	1 457 434 408	N 4408
1 457 433 542	S 3542	1 457 433 712	S 3712	1 457 433 968	S 3968	1 457 434 409	N 4409
1 457 433 544	S 3544	1 457 433 713	S 3713	1 457 433 969	S 3969	1 457 434 416	N 4416
1 457 433 548	S 3548	1 457 433 722	S 3722	1 457 433 970	S 3970	1 457 434 419	N 4419
1 457 433 555	S 3555	1 457 433 726	S 3726	1 457 433 971	S 3971	1 457 434 421	N 4421
1 457 433 557	S 3557	1 457 433 728	S 3728	1 457 433 972	S 3972	1 457 434 423	N 4423
1 457 433 558	S 3558	1 457 433 729	S 3729	1 457 434 050	N 4050	1 457 434 428	N 4428
1 457 433 564	S 3564	1 457 433 730	S 3730	1 457 434 051	N 4051	1 457 434 429	N 4429
1 457 433 566	S 3566	1 457 433 731	S 3731	1 457 434 062	N 4062	1 457 434 432	N 4432
1 457 433 568	S 3568	1 457 433 734	S 3734	1 457 434 103	N 4103	1 457 434 433	N 4433
1 457 433 574	S 3574	1 457 433 735	S 3735	1 457 434 105	N 4105	1 457 434 435	N 4435
1 457 433 577	S 3577	1 457 433 741	S 3741	1 457 434 106	N 4106	1 457 434 436	N 4436
1 457 433 578	S 3578	1 457 433 743	S 3743	1 457 434 123	N 4123	1 457 434 437	N 4437
1 457 433 580	S 3580	1 457 433 745	S 3745	1 457 434 150	N 4150	1 457 434 438	N 4438
1 457 433 584	S 3584	1 457 433 750	S 3750	1 457 434 153	N 4153	1 457 434 439	N 4439
1 457 433 588	S 3588	1 457 433 769	S 3769	1 457 434 154	N 4154	1 457 434 440	N 4440
1 457 433 589	S 3589	1 457 433 772	S 3772	1 457 434 156	N 4156	1 457 434 443	N 4443
1 457 433 594	S 3594	1 457 433 773	S 3773	1 457 434 165	N 4165	1 457 434 447	N 4447
1 457 433 595	S 3595	1 457 433 775	S 3775	1 457 434 174	N 4174	1 457 434 448	N 4448
1 457 433 596	S 3596	1 457 433 784	S 3784	1 457 434 180	N 4180	1 457 434 450	N 4450
1 457 433 601	S 3601	1 457 433 785	S 3785	1 457 434 184	N 4184	1 457 434 451	N 4451
1 457 433 605	S 3605	1 457 433 786	S 3786	1 457 434 186	N 4186	1 457 434 452	N 4452
1 457 433 610	S 3610	1 457 433 789	S 3789	1 457 434 187	N 4187	1 457 434 453	N 4453
1 457 433 611	S 3611	1 457 433 790	S 3790	1 457 434 192	N 4192	1 457 434 454	N 4454
1 457 433 616	S 3616	1 457 433 792	S 3792	1 457 434 194	N 4194	1 457 434 455	N 4455
1 457 433 617	S 3617	1 457 433 795	S 3795	1 457 434 198	N 4198	1 457 434 456	N 4456
1 457 433 620	S 3620	1 457 433 797	S 3797	1 457 434 200	N 4200	1 457 434 457	N 4457
1 457 433 623	S 3623	1 457 433 799	S 3799	1 457 434 201	N 4201	1 457 434 459	N 4459
1 457 433 624	S 3624	1 457 433 800	S 3800	1 457 434 281	N 4281	1 457 434 460	N 4460
1 457 433 626	S 3626	1 457 433 900	S 3900	1 457 434 291	N 4291	1 457 434 510	N 4510

de

Gegenüberstellung
Bestellnummer →
Suchnummer
(Fortsetzung)

en

Cross references
part number →
search number
(continued)

fr



Table de correspon-
dance référence →
code d'identification
(suite)

it

Confronto codice di
ordinazione → codice
breve
(seguito)

es

Confrontación refe-
rencia de pedido →
referencia comercial
(continuación)

	 N°
1 457 434 511	N 4511
1 457 434 516	N 4516
1 457 437 001	P 7001
1 457 437 002	P 7002
1 457 437 003	P 7003

1 987 ...	
1 987 429 004	S 9004
1 987 429 012	S 9012
1 987 429 036	S 9036

1 987 429 040	S 9040
1 987 429 042	S 9042/1
1 987 429 046	S 9046
1 987 429 051	S 9051
1 987 429 107	S 9107

1 987 429 109	S 9109
1 987 429 115	S 9115
1 987 429 117	S 9117
1 987 429 120	S 9120
1 987 429 121	S 9121



1 987 429 122	S 9122
1 987 429 123	S 9123
1 987 429 125	S 9125
1 987 429 127	S 9127
1 987 429 128	S 9128

1 987 429 133	S 9133
1 987 429 135	S 9135
1 987 429 136	S 9136
1 987 429 137	S 9137
1 987 429 146	S 9146

1 987 429 148	S 9148
1 987 429 149	S 9149
1 987 429 150	S 9150
1 987 429 151	S 9151
1 987 429 152	S 9152

1 987 429 154	S 9154
1 987 429 155	S 9155
1 987 429 156	S 9156
1 987 429 157	S 9157
1 987 429 158	S 9158

1 987 429 159	S 9159
1 987 429 161	S 9161
1 987 429 162	S 9162
1 987 429 163	S 9163
1 987 429 164	S 9164

	 N°
1 987 429 167	S 9167
1 987 429 169	S 9169
1 987 429 170	S 9170
1 987 429 171	S 9171
1 987 429 172	S 9172

1 987 429 173	S 9173
1 987 429 174	S 9174
1 987 429 175	S 9175
1 987 429 176	S 9176
1 987 429 177	S 9177

1 987 429 178	S 9178
1 987 429 179	S 9179
1 987 429 180	S 9180
1 987 429 182	S 9182
1 987 429 183	S 9183

1 987 429 184	S 9184
1 987 429 185	S 9185
1 987 429 186	S 9186
1 987 429 187	S 9187
1 987 429 191	S 9191



1 987 429 192	S 9192
1 987 431 154	M 1154
1 987 431 155	M 1155
1 987 431 156	M 1156
1 987 431 157	M 1157

1 987 431 159	M 1159
1 987 431 162	M 1162
1 987 431 163	M 1163
1 987 431 164	M 1164
1 987 431 165	M 1165

1 987 431 166	M 1166
1 987 431 167	M 1167
1 987 431 168	M 1168
1 987 431 169	M 1169
1 987 431 170	M 1170

1 987 431 171	M 1171
1 987 431 172	M 1172
1 987 431 174	M 1174
1 987 431 175	M 1175
1 987 431 176	M 1176

1 987 431 178	M 1178
1 987 431 181	M 1181
1 987 431 187	M 1187
1 987 431 189	M 1189
1 987 431 191	M 1191

	 N°
1 987 431 204	M 1204
1 987 431 206	M 1206
1 987 431 210	M 1210
1 987 431 223	M 1223
1 987 431 224	M 1224

1 987 431 229	M 1229
1 987 431 451	R 1451
1 987 431 452	R 1452
1 987 431 454	R 1454
1 987 431 455	R 1455

1 987 431 456	R 1456
1 987 431 457	R 1457
1 987 431 458	R 1458
1 987 432 004	M 2004
1 987 432 034	M 2034

1 987 432 041	M 2041
1 987 432 042	M 2042
1 987 432 052	M 2052
1 987 432 058	M 2058
1 987 432 060	M 2060



1 987 432 065	M 2065
1 987 432 066	M 2066
1 987 432 075	M 2075
1 987 432 080	M 2080
1 987 432 084	M 2084

1 987 432 085	M 2085
1 987 432 086	M 2086
1 987 432 088	M 2088
1 987 432 091	M 2091
1 987 432 092	M 2092

1 987 432 100	M 2100
1 987 432 105	M 2105
1 987 432 107	M 2107
1 987 432 108	M 2108
1 987 432 109	M 2109

1 987 432 112	M 2112
1 987 432 114	M 2114
1 987 432 115	M 2115
1 987 432 117	M 2117
1 987 432 118	M 2118

1 987 432 119	M 2119
1 987 432 132	M 2132
1 987 432 133	M 2133
1 987 432 148	M 2148
1 987 432 150	M 2150

	 N°
1 987 432 151	M 2151
1 987 432 152	M 2152
1 987 432 153	M 2153
1 987 432 155	M 2155
1 987 432 156	M 2156

1 987 432 157	M 2157
1 987 432 159	M 2159
1 987 432 160	M 2160
1 987 432 161	M 2161
1 987 432 162	M 2162

1 987 432 163	M 2163
1 987 432 164	M 2164
1 987 432 166	M 2166
1 987 432 167	M 2167
1 987 432 171	M 2171

1 987 432 172	M 2172
1 987 432 173	M 2173
1 987 432 175	M 2175
1 987 432 176	M 2176
1 987 432 177	M 2177

1 987 432 179	M 2179
1 987 432 183	M 2183
1 987 432 189	M 2189
1 987 432 190	M 2190
1 987 432 192	M 2192

1 987 432 194	M 2194
1 987 432 198	M 2198
1 987 432 203	M 2203
1 987 432 204	M 2204
1 987 432 206	M 2206

1 987 432 207	M 2207
1 987 432 208	M 2208
1 987 432 209	M 2209
1 987 432 210	M 2210
1 987 432 211	M 2211

1 987 432 213	M 2213
1 987 432 214	M 2214
1 987 432 215	M 2215
1 987 432 216	M 2216
1 987 432 218	M 2218

1 987 432 220	M 2220
1 987 432 221	M 2221
1 987 432 222	M 2222
1 987 432 223	M 2223
1 987 432 224	M 2224

nl

Omzettingslijst
Bestelnummer →
Opzoeknummer
(vervolg)

sv

Artikelnummer →
Söknummer
(fortsättning)

cs

Převod objednáací číslo →
vyhledávací číslo
(pokračování)

pl

Zestawienie
numer katalogowy →
numer identyfikacyjny
(ciąg dalszy)

ru

Соответствие Номер
артикула →
Поисковый номер
(продолжение)



1 987 432 225	M 2225
1 987 432 227	M 2227
1 987 432 228	M 2228
1 987 432 229	M 2229
1 987 432 230	M 2230

1 987 432 231	M 2231
1 987 432 234	M 2234
1 987 432 236	M 2236
1 987 432 238	M 2238
1 987 432 239	M 2239

1 987 432 240	M 2240
1 987 432 241	M 2241
1 987 432 246	M 2246
1 987 432 247	M 2247
1 987 432 250	M 2250

1 987 432 251	M 2251
1 987 432 253	M 2253
1 987 432 254	M 2254
1 987 432 255	M 2255
1 987 432 257	M 2257

1 987 432 259	M 2259
1 987 432 260	M 2260
1 987 432 262	M 2262
1 987 432 263	M 2263
1 987 432 267	M 2267

1 987 432 269	M 2269
1 987 432 272	M 2272
1 987 432 273	M 2273
1 987 432 274	M 2274
1 987 432 275	M 2275

1 987 432 277	M 2277
1 987 432 278	M 2278
1 987 432 306	R 2306
1 987 432 319	R 2319
1 987 432 320	R 2320

1 987 432 383	R 2383
1 987 432 392	R 2392
1 987 432 394	R 2394
1 987 432 400	R 2400
1 987 432 406	R 2406

1 987 432 415	R 2415
1 987 432 416	R 2416
1 987 432 426	R 2426
1 987 432 435	R 2435
1 987 432 436	R 2436



1 987 432 464	R 2464
1 987 432 488	R 2488
1 987 432 498	R 2498
1 987 432 500	R 2500
1 987 432 513	R 2513

1 987 432 525	R 2525
1 987 432 531	R 2531
1 987 432 535	R 2535
1 987 432 542	R 2542
1 987 432 545	R 2545

1 987 432 548	R 2548
1 987 432 549	R 2549
1 987 432 566	R 2566
1 987 432 568	R 2568
1 987 432 571	R 2571

1 987 432 574	R 2574
1 987 432 598	R 2598

F 026 ...

F 026 400 001	S 0001
F 026 400 006	S 0006
F 026 400 007	S 0007

F 026 400 012	S 0012
F 026 400 013	S 0013
F 026 400 014	S 0014
F 026 400 015	S 0015
F 026 400 016	S 0016

F 026 400 017	S 0017
F 026 400 019	S 0019
F 026 400 020	S 0020
F 026 400 022	S 0022
F 026 400 023	S 0023

F 026 400 024	S 0024
F 026 400 025	S 0025
F 026 400 027	S 0027
F 026 400 028	S 0028
F 026 400 033	S 0033

F 026 400 034	S 0034
F 026 400 037	S 0037
F 026 400 038	S 0038
F 026 400 040	S 0040
F 026 400 041	S 0041



F 026 400 043	S 0043
F 026 400 044	S 0044
F 026 400 045	S 0045
F 026 400 046	S 0046
F 026 400 048	S 0048

F 026 400 049	S 0049
F 026 400 051	S 0051
F 026 400 052	S 0052
F 026 400 054	S 0054
F 026 400 055	S 0055

F 026 400 056	S 0056
F 026 400 058	S 0058
F 026 400 059	S 0059
F 026 400 060	S 0060
F 026 400 061	S 0061

F 026 400 062	S 0062
F 026 400 064	S 0064
F 026 400 065	S 0065
F 026 400 067	S 0067
F 026 400 068	S 0068

F 026 400 069	S 0069
F 026 400 070	S 0070
F 026 400 071	S 0071
F 026 400 072	S 0072
F 026 400 073	S 0073

F 026 400 074	S 0074
F 026 400 075	S 0075
F 026 400 076	S 0076
F 026 400 077	S 0077
F 026 400 078	S 0078

F 026 400 079	S 0079
F 026 400 080	S 0080
F 026 400 082	S 0082
F 026 400 083	S 0083
F 026 400 084	S 0084

F 026 400 085	S 0085
F 026 400 086	S 0086
F 026 400 087	S 0087
F 026 400 088	S 0088
F 026 400 090	S 0090

F 026 400 091	S 0091
F 026 400 092	S 0092
F 026 400 093	S 0093
F 026 400 094	S 0094
F 026 400 096	S 0096



F 026 400 097	S 0097
F 026 400 098	S 0098
F 026 400 101	S 0101
F 026 400 102	S 0102
F 026 400 103	S 0103

F 026 400 106	S 0106
F 026 400 107	S 0107
F 026 400 109	S 0109
F 026 400 110	S 0110
F 026 400 111	S 0111

F 026 400 113	S 0113
F 026 400 114	S 0114
F 026 400 117	S 0117
F 026 400 119	S 0119
F 026 400 121	S 0121

F 026 400 123	S 0123
F 026 400 125	S 0125
F 026 400 126	S 0126
F 026 400 127	S 0127
F 026 400 128	S 0128

F 026 400 129	S 0129
F 026 400 130	S 0130
F 026 400 132	S 0132
F 026 400 133	S 0133
F 026 400 135	S 0135

F 026 400 137	S 0137
F 026 400 138	S 0138
F 026 400 140	S 0140
F 026 400 143	S 0143
F 026 400 145	S 0145

F 026 400 147	S 0147
F 026 400 150	S 0150
F 026 400 153	S 0153
F 026 400 154	S 0154
F 026 400 158	S 0158

F 026 400 159	S 0159
F 026 400 160	S 0160
F 026 400 161	S 0161
F 026 400 162	S 0162
F 026 400 163	S 0163

F 026 400 165	S 0165
F 026 400 166	S 0166
F 026 400 167	S 0167
F 026 400 168	S 0168
F 026 400 169	S 0169

de

Gegenüberstellung
Bestellnummer →
Suchnummer
(Fortsetzung)

en

Cross references
part number →
search number
(continued)

fr

Table de correspon-
dance référence →
code d'identification
(suite)

it

Confronto codice di
ordinazione → codice
breve
(seguito)

es

Confrontación refe-
rencia de pedido →
referencia comercial
(continuación)



F 026 400 170	S 0170
F 026 400 171	S 0171
F 026 400 173	S 0173
F 026 400 174	S 0174
F 026 400 175	S 0175
F 026 400 176	S 0176
F 026 400 177	S 0177
F 026 400 179	S 0179
F 026 400 182	S 0182
F 026 400 183	S 0183
F 026 400 184	S 0184
F 026 400 186	S 0186
F 026 400 187	S 0187
F 026 400 188	S 0188
F 026 400 189	S 0189
F 026 400 190	S 0190
F 026 400 191	S 0191
F 026 400 192	S 0192
F 026 400 193	S 0193
F 026 400 194	S 0194
F 026 400 195	S 0195
F 026 400 196	S 0196
F 026 400 197	S 0197
F 026 400 199	S 0199
F 026 400 200	S 0200
F 026 400 201	S 0201
F 026 400 202	S 0202
F 026 400 203	S 0203
F 026 400 204	S 0204
F 026 400 205	S 0205
F 026 400 206	S 0206
F 026 400 207	S 0207
F 026 400 209	S 0209
F 026 400 210	S 0210
F 026 400 211	S 0211
F 026 400 212	S 0212
F 026 400 214	S 0214
F 026 400 217	S 0217
F 026 400 218	S 0218
F 026 400 219	S 0219
F 026 400 220	S 0220
F 026 400 221	S 0221
F 026 400 222	S 0222
F 026 400 223	S 0223
F 026 400 224	S 0224



F 026 400 225	S 0225
F 026 400 226	S 0226
F 026 400 227	S 0227
F 026 400 228	S 0228
F 026 400 229	S 0229
F 026 400 230	S 0230
F 026 400 231	S 0231
F 026 400 232	S 0232
F 026 400 234	S 0234
F 026 400 236	S 0236
F 026 400 243	S 0243
F 026 400 244	S 0244
F 026 400 245	S 0245
F 026 400 247	S 0247
F 026 400 249	S 0249
F 026 400 250	S 0250
F 026 400 251	S 0251
F 026 400 252	S 0252
F 026 400 255	S 0255
F 026 400 256	S 0256
F 026 400 257	S 0257
F 026 400 258	S 0258
F 026 400 261	S 0261
F 026 400 263	S 0263
F 026 400 264	S 0264
F 026 400 265	S 0265
F 026 400 266	S 0266
F 026 400 267	S 0267
F 026 400 268	S 0268
F 026 400 271	S 0271
F 026 400 272	S 0272
F 026 400 275	S 0275
F 026 400 276	S 0276
F 026 400 277	S 0277
F 026 400 278	S 0278
F 026 400 279	S 0279
F 026 400 280	S 0280
F 026 400 282	S 0282
F 026 400 283	S 0283
F 026 400 285	S 0285
F 026 400 286	S 0286
F 026 400 287	S 0287
F 026 400 288	S 0288
F 026 400 290	S 0290
F 026 400 291	S 0291



F 026 400 293	S 0293
F 026 400 294	S 0294
F 026 400 295	S 0295
F 026 400 296	S 0296
F 026 400 299	S 0299
F 026 400 304	S 0304
F 026 400 309	S 0309
F 026 400 310	S 0310
F 026 400 312	S 0312
F 026 400 314	S 0314
F 026 400 320	S 0320
F 026 400 322	S 0322
F 026 400 323	S 0323
F 026 400 327	S 0327
F 026 400 329	S 0329
F 026 400 330	S 0330
F 026 402 001	N 2001
F 026 402 002	N 2002
F 026 402 003	N 2003
F 026 402 004	N 2004
F 026 402 005	N 2005
F 026 402 007	N 2007
F 026 402 008	N 2008
F 026 402 013	N 2013
F 026 402 016	N 2016
F 026 402 017	N 2017
F 026 402 019	N 2019
F 026 402 025	N 2025
F 026 402 028	N 2028
F 026 402 029	N 2029
F 026 402 030	N 2030
F 026 402 031	N 2031
F 026 402 032	N 2032
F 026 402 033	N 2033
F 026 402 034	N 2034
F 026 402 035	N 2035
F 026 402 036	N 2036
F 026 402 037	N 2037
F 026 402 038	N 2038
F 026 402 040	N 2040
F 026 402 043	N 2043
F 026 402 044	N 2044
F 026 402 045	N 2045
F 026 402 046	N 2046
F 026 402 047	N 2047



F 026 402 048	N 2048
F 026 402 049	N 2049
F 026 402 051	N 2051
F 026 402 054	N 2054
F 026 402 056	N 2056
F 026 402 059	N 2059
F 026 402 061	N 2061
F 026 402 062	N 2062
F 026 402 063	N 2063
F 026 402 065	N 2065
F 026 402 066	N 2066
F 026 402 067	N 2067
F 026 402 068	N 2068
F 026 402 070	N 2070
F 026 402 072	N 2072
F 026 402 073	N 2073
F 026 402 074	N 2074
F 026 402 075	N 2075
F 026 402 076	N 2076
F 026 402 077	N 2077
F 026 402 079	N 2079
F 026 402 080	N 2080
F 026 402 081	N 2081
F 026 402 082	N 2082
F 026 402 084	N 2084
F 026 402 085	N 2085
F 026 402 086	N 2086
F 026 402 087	N 2087
F 026 402 088	N 2088
F 026 402 090	N 2090
F 026 402 091	N 2091
F 026 402 092	N 2092
F 026 402 093	N 2093
F 026 402 094	N 2094
F 026 402 095	N 2095
F 026 402 098	N 2098
F 026 402 100	N 2100
F 026 402 101	N 2101
F 026 402 103	N 2103
F 026 402 104	N 2104
F 026 402 106	N 2106
F 026 402 107	N 2107
F 026 402 108	N 2108
F 026 402 111	N 2111
F 026 402 113	N 2113

nl

Omzettingslijst
Bestelnummer →
Opzoeknummer
(vervolg)

sv

Artikelnummer →
Söknummer
(fortsättning)

cs









Převod objednáací číslo →
vyhledávací číslo
(pokračování)

pl

Zestawienie
numer katalogowy →
numer identyfikacyjny
(ciąg dalszy)

ru

Соответствие Номер
артикула →
Поисковый номер
(продолжение)

  №		  №		  №		  №	
F 026 402 114	N 2114	F 026 407 003	P 7003/1	F 026 407 097	P 7097		
F 026 402 115	N 2115	F 026 407 014	P 7014	F 026 407 098	P 7098		
F 026 402 118	N 2118	F 026 407 017	P 7017	F 026 407 099	P 7099		
F 026 402 119	N 2119	F 026 407 018	P 7018	F 026 407 100	P 7100		
F 026 402 120	N 2120	F 026 407 021	P 7021	F 026 407 101	P 7101		
F 026 402 121	N 2121	F 026 407 023	P 7023	F 026 407 104	P 7104		
F 026 402 122	N 2122	F 026 407 024	P 7024	F 026 407 105	P 7105		
F 026 402 124	N 2124	F 026 407 025	P 7025	F 026 407 106	P 7106		
F 026 402 125	N 2125	F 026 407 026	P 7026	F 026 407 108	P 7108		
F 026 402 126	N 2126	F 026 407 027	P 7027	F 026 407 109	P 7109		
F 026 402 127	N 2127	F 026 407 040	P 7040	F 026 407 112	P 7112		
F 026 402 128	N 2128	F 026 407 042	P 7042	F 026 407 116	P 7116		
F 026 402 134	N 2134	F 026 407 043	P 7043	F 026 407 118	P 7118		
F 026 402 136	N 2136	F 026 407 044	P 7044	F 026 407 119	P 7119		
F 026 402 138	N 2138	F 026 407 045	P 7045	F 026 407 122	P 7122		
F 026 402 140	N 2140	F 026 407 046	P 7046	F 026 407 123	P 7123		
F 026 402 143	N 2143	F 026 407 047	P 7047	F 026 407 125	P 7125		
F 026 402 808	N 2808	F 026 407 048	P 7048	F 026 407 130	P 7130		
F 026 402 809	N 2809	F 026 407 049	P 7049	F 026 407 143	P 7143		
F 026 402 810	N 2810	F 026 407 051	P 7051	F 026 407 144	P 7144		
F 026 402 811	N 2811	F 026 407 053	P 7053	F 026 407 147	P 7147		
F 026 402 812	N 2812	F 026 407 054	P 7054				
F 026 403 000	F 3000	F 026 407 057	P 7057				
F 026 403 001	F 3001	F 026 407 058	P 7058				
F 026 403 002	F 3002	F 026 407 059	P 7059				
F 026 403 003	F 3003	F 026 407 060	P 7060				
F 026 403 005	F 3005	F 026 407 061	P 7061				
F 026 403 006	F 3006	F 026 407 062	P 7062				
F 026 403 008	F 3008	F 026 407 066	P 7066				
F 026 403 009	F 3009	F 026 407 068	P 7068				
F 026 403 012	F 3012	F 026 407 069	P 7069				
F 026 403 013	F 3013	F 026 407 070	P 7070				
F 026 403 014	F 3014	F 026 407 071	P 7071				
F 026 403 015	F 3015	F 026 407 072	P 7072				
F 026 403 016	F 3016	F 026 407 073	P 7073				
F 026 403 019	F 3019	F 026 407 076	P 7076				
F 026 403 020	F 3020	F 026 407 077	P 7077				
F 026 403 021	F 3021	F 026 407 083	P 7083				
F 026 403 754	F 3754	F 026 407 090	P 7090				
F 026 403 755	F 3755	F 026 407 091	P 7091				
F 026 403 757	F 3757	F 026 407 092	P 7092				
F 026 403 758	F 3758	F 026 407 093	P 7093				
F 026 404 004	Z 4004	F 026 407 094	P 7094				
F 026 407 001	P 7001/1	F 026 407 095	P 7095				
F 026 407 002	P 7002/1	F 026 407 096	P 7096				

de

Gegenüberstellung
Suchnummer →
Bestellnummer

en

Cross references
search number →
part number

fr

Table de correspon-
dance code d'identi-
fication → référence

it

Confronto codice breve →
codice di ordinazione

es

Confrontación refe-
rencia comercial →
referencia de pedido



F ...	
F 0018	0 986 450 018
F 0030	0 986 450 030
F 0037	0 986 450 037
F 0039	0 986 450 039
F 0100	0 986 450 100
F 0102	0 986 450 102
F 0103	0 986 450 103
F 0104	0 986 450 104
F 0105	0 986 450 105
F 0106	0 986 450 106
F 0107	0 986 450 107
F 0108	0 986 450 108
F 0109	0 986 450 109
F 0110	0 986 450 110
F 0111	0 986 450 111
F 0113	0 986 450 113
F 0114	0 986 450 114
F 0115	0 986 450 115
F 0117	0 986 450 117
F 0119	0 986 450 119
F 0120	0 986 450 120
F 0121	0 986 450 121
F 0123	0 986 450 123
F 0124	0 986 450 124
F 0137	0 986 450 137
F 0138	0 986 450 138
F 0143	0 986 450 143
F 0212	0 986 450 212
F 0220	0 986 450 220
F 0221	0 986 450 221
F 0222	0 986 450 222
F 0225	0 986 450 225
F 0226	0 986 450 226
F 0510	0 986 450 510
F 0604	0 986 450 604
F 0614	0 986 450 614
F 0624	0 986 450 624
F 1005	0 450 901 005
F 2151	0 450 902 151
F 2161	0 450 902 161
F 2162	0 450 902 162
F 3000	F 026 403 000
F 3001	F 026 403 001



F 3002	F 026 403 002
F 3003	F 026 403 003
F 3005	F 026 403 005
F 3006	F 026 403 006
F 3008	F 026 403 008
F 3009	F 026 403 009
F 3012	F 026 403 012
F 3013	F 026 403 013
F 3014	F 026 403 014
F 3015	F 026 403 015
F 3016	F 026 403 016
F 3019	F 026 403 019
F 3020	F 026 403 020
F 3021	F 026 403 021
F 3754	F 026 403 754
F 3755	F 026 403 755
F 3757	F 026 403 757
F 3758	F 026 403 758
F 4058	0 450 904 058
F 4149	0 450 904 149
F 4159	0 450 904 159
F 4162	0 450 904 162
F 4163	0 450 904 163
F 5001	0 450 915 001
F 5002	0 450 905 002
F 5003/1	0 450 915 003
F 5005	0 450 905 005
F 5016	0 450 905 016
F 5021	0 450 905 021
F 5030	0 450 905 030
F 5066	0 450 905 066
F 5087	0 450 905 087
F 5091	0 450 905 091
F 5095	0 450 905 095
F 5104	0 450 905 104
F 5133	0 450 905 133
F 5139	0 450 905 139
F 5143	0 450 905 143
F 5145	0 450 905 145
F 5177	0 450 905 177
F 5200	0 450 905 200
F 5203	0 450 905 203
F 5215	0 450 905 215
F 5216	0 450 905 216
F 5219	0 450 905 219



F 5264	0 450 905 264
F 5273	0 450 905 273
F 5280	0 450 905 280
F 5281	0 450 905 281
F 5287	0 450 905 287
F 5316	0 450 905 316
F 5318	0 450 905 318
F 5320	0 450 905 320
F 5324	0 450 905 324
F 5326	0 450 905 326
F 5401	0 450 905 401
F 5601	0 450 905 601
F 5901	0 450 905 901
F 5903	0 450 905 903
F 5904	0 450 905 904
F 5906	0 450 905 906
F 5908	0 450 905 908
F 5909	0 450 905 909
F 5911	0 450 905 911
F 5912	0 450 905 912
F 5914	0 450 905 914
F 5915	0 450 905 915
F 5916	0 450 905 916
F 5920	0 450 905 920
F 5921	0 450 905 921
F 5922	0 450 905 922
F 5923	0 450 905 923
F 5924	0 450 905 924
F 5925	0 450 905 925
F 5926	0 450 905 926
F 5927	0 450 905 927
F 5928	0 450 905 928
F 5929	0 450 905 929
F 5939	0 450 905 939
F 5940	0 450 905 940
F 5943	0 450 905 943
F 5944	0 450 905 944
F 5950	0 450 905 950
F 5951	0 450 905 951
F 5952	0 450 905 952
F 5953	0 450 905 953
F 5954	0 450 905 954
F 5955	0 450 905 955
F 5956	0 450 905 956
F 5957	0 450 905 957



F 5958	0 450 905 958
F 5959	0 450 905 959
F 5960	0 450 905 960
F 5961	0 450 905 961
F 5962	0 450 905 962
F 5963	0 450 905 963
F 5964	0 450 905 964
F 5966	0 450 905 966
F 5967	0 450 905 967
F 5968	0 450 905 968
F 5969	0 450 905 969
F 5971	0 450 905 971
F 5972	0 450 905 972
F 5973	0 450 905 973
F 5974	0 450 905 974
F 5975	0 450 905 975
F 5976	0 450 905 976
F 5977	0 450 905 977
F 5978	0 450 905 978
F 5979	0 450 905 979
F 5980	0 450 905 980
F 5981	0 450 905 981
F 5982	0 450 905 982
F 5983	0 450 905 983
F 5985	0 450 905 985
F 5986	0 450 905 986
F 5987	0 450 905 987
F 5988	0 450 905 988
F 5989	0 450 905 989
F 5990	0 450 905 990
M ...	
M 1154	1 987 431 154
M 1155	1 987 431 155
M 1156	1 987 431 156
M 1157	1 987 431 157
M 1159	1 987 431 159
M 1162	1 987 431 162
M 1163	1 987 431 163
M 1164	1 987 431 164
M 1165	1 987 431 165
M 1166	1 987 431 166
M 1167	1 987 431 167
M 1168	1 987 431 168
M 1169	1 987 431 169

nl	sv	cs	pl	ru
Omzettingslijst Opzoeknummer → Bestelnummer (vervolg)	Söknummer → Artikelnummer (fortsättning)	Převod vyhledávací číslo → objednáací číslo (pokračování)	Zestawienie numer identyfikacyjny → numer katalogowy (ciąg dalszy)	Соответствие Поисковый номер → Номер артикула (продолжение)



M 1170	1 987 431 170
M 1171	1 987 431 171
M 1172	1 987 431 172
M 1174	1 987 431 174
M 1175	1 987 431 175

M 1176	1 987 431 176
M 1178	1 987 431 178
M 1181	1 987 431 181
M 1187	1 987 431 187
M 1189	1 987 431 189

M 1191	1 987 431 191
M 1204	1 987 431 204
M 1206	1 987 431 206
M 1210	1 987 431 210
M 1223	1 987 431 223

M 1224	1 987 431 224
M 1229	1 987 431 229
M 2004	1 987 432 004
M 2034	1 987 432 034
M 2041	1 987 432 041

M 2042	1 987 432 042
M 2052	1 987 432 052
M 2058	1 987 432 058
M 2060	1 987 432 060
M 2065	1 987 432 065

M 2066	1 987 432 066
M 2075	1 987 432 075
M 2080	1 987 432 080
M 2084	1 987 432 084
M 2085	1 987 432 085

M 2086	1 987 432 086
M 2088	1 987 432 088
M 2091	1 987 432 091
M 2092	1 987 432 092
M 2100	1 987 432 100

M 2105	1 987 432 105
M 2107	1 987 432 107
M 2108	1 987 432 108
M 2109	1 987 432 109
M 2112	1 987 432 112

M 2114	1 987 432 114
M 2115	1 987 432 115
M 2117	1 987 432 117
M 2118	1 987 432 118
M 2119	1 987 432 119



M 2132	1 987 432 132
M 2133	1 987 432 133
M 2148	1 987 432 148
M 2150	1 987 432 150
M 2151	1 987 432 151

M 2152	1 987 432 152
M 2153	1 987 432 153
M 2155	1 987 432 155
M 2156	1 987 432 156
M 2157	1 987 432 157

M 2159	1 987 432 159
M 2160	1 987 432 160
M 2161	1 987 432 161
M 2162	1 987 432 162
M 2163	1 987 432 163

M 2164	1 987 432 164
M 2166	1 987 432 166
M 2167	1 987 432 167
M 2171	1 987 432 171
M 2172	1 987 432 172

M 2173	1 987 432 173
M 2175	1 987 432 175
M 2176	1 987 432 176
M 2177	1 987 432 177
M 2179	1 987 432 179

M 2183	1 987 432 183
M 2189	1 987 432 189
M 2190	1 987 432 190
M 2192	1 987 432 192
M 2194	1 987 432 194

M 2198	1 987 432 198
M 2203	1 987 432 203
M 2204	1 987 432 204
M 2206	1 987 432 206
M 2207	1 987 432 207

M 2208	1 987 432 208
M 2209	1 987 432 209
M 2210	1 987 432 210
M 2211	1 987 432 211
M 2213	1 987 432 213

M 2214	1 987 432 214
M 2215	1 987 432 215
M 2216	1 987 432 216
M 2218	1 987 432 218
M 2220	1 987 432 220



M 2221	1 987 432 221
M 2222	1 987 432 222
M 2223	1 987 432 223
M 2224	1 987 432 224
M 2225	1 987 432 225

M 2227	1 987 432 227
M 2228	1 987 432 228
M 2229	1 987 432 229
M 2230	1 987 432 230
M 2231	1 987 432 231

M 2234	1 987 432 234
M 2236	1 987 432 236
M 2238	1 987 432 238
M 2239	1 987 432 239
M 2240	1 987 432 240

M 2241	1 987 432 241
M 2246	1 987 432 246
M 2247	1 987 432 247
M 2250	1 987 432 250
M 2251	1 987 432 251

M 2253	1 987 432 253
M 2254	1 987 432 254
M 2255	1 987 432 255
M 2257	1 987 432 257
M 2259	1 987 432 259

M 2260	1 987 432 260
M 2262	1 987 432 262
M 2263	1 987 432 263
M 2267	1 987 432 267
M 2269	1 987 432 269

M 2272	1 987 432 272
M 2273	1 987 432 273
M 2274	1 987 432 274
M 2275	1 987 432 275
M 2277	1 987 432 277

M 2278	1 987 432 278
--------	----------------------

N ...	
N 0000	1 457 070 000
N 0001	1 457 070 001
N 0007	1 457 070 007



N 0008	1 457 070 008
N 0010	1 457 070 010
N 0013	1 457 030 013
N 0508	0 986 450 508
N 0509	0 986 450 509

N 1028	1 457 431 028
N 1158	1 457 431 158
N 1159	1 457 431 159
N 1261	1 457 431 261
N 1270	1 457 431 270

N 1325	1 457 431 325
N 1326	1 457 431 326
N 1702	1 457 431 702
N 1703	1 457 431 703
N 1704	1 457 431 704

N 1705	1 457 431 705
N 1707	1 457 431 707
N 1708	1 457 431 708
N 1710	1 457 431 710
N 1712	1 457 431 712

N 1713	1 457 431 713
N 1718	1 457 431 718
N 1720	1 457 431 720
N 1723	1 457 431 723
N 1724	1 457 431 724

N 1729	1 457 431 729
N 2001	F 026 402 001
N 2002	F 026 402 002
N 2003	F 026 402 003
N 2004	F 026 402 004

N 2005	F 026 402 005
N 2007	F 026 402 007
N 2008	F 026 402 008
N 2013	F 026 402 013
N 2016	F 026 402 016

N 2017	F 026 402 017
N 2019	F 026 402 019
N 2025	F 026 402 025
N 2028	F 026 402 028
N 2029	F 026 402 029

N 2030	F 026 402 030
N 2031	F 026 402 031
N 2032	F 026 402 032
N 2033	F 026 402 033
N 2034	F 026 402 034

de

**Gegenüberstellung
Suchnummer →
Bestellnummer**
(Fortsetzung)

en

**Cross references
search number →
part number**
(continued)

fr



**Table de correspon-
dance code d'identi-
fication → référence**
(suite)



it



**Confronto codice breve →
codice di ordinazione**
(seguito)



es

**Confrontación refe-
rencia comercial →
referencia de pedido**
(continuación)



 N°	
N 2035	F 026 402 035
N 2036	F 026 402 036
N 2037	F 026 402 037
N 2038	F 026 402 038
N 2040	F 026 402 040
N 2043	F 026 402 043
N 2044	F 026 402 044
N 2045	F 026 402 045
N 2046	F 026 402 046
N 2047	F 026 402 047
N 2048	F 026 402 048
N 2049	F 026 402 049
N 2051	F 026 402 051
N 2054	F 026 402 054
N 2056	F 026 402 056
N 2059	F 026 402 059
N 2061	F 026 402 061
N 2062	F 026 402 062
N 2063	F 026 402 063
N 2065	F 026 402 065
N 2066	F 026 402 066
N 2067	F 026 402 067
N 2068	F 026 402 068
N 2070	F 026 402 070
N 2072	F 026 402 072
N 2073	F 026 402 073
N 2074	F 026 402 074
N 2075	F 026 402 075
N 2076	F 026 402 076
N 2077	F 026 402 077
N 2079	F 026 402 079
N 2080	F 026 402 080
N 2081	F 026 402 081
N 2082	F 026 402 082
N 2084	F 026 402 084
N 2085	F 026 402 085
N 2086	F 026 402 086
N 2087	F 026 402 087
N 2088	F 026 402 088
N 2090	F 026 402 090
N 2091	F 026 402 091
N 2092	F 026 402 092
N 2093	F 026 402 093
N 2094	F 026 402 094
N 2095	F 026 402 095



 N°	
N 2098	F 026 402 098
N 2100	F 026 402 100
N 2101	F 026 402 101
N 2103	F 026 402 103
N 2104	F 026 402 104
N 2106	F 026 402 106
N 2107	F 026 402 107
N 2108	F 026 402 108
N 2111	F 026 402 111
N 2113	F 026 402 113
N 2114	F 026 402 114
N 2115	F 026 402 115
N 2118	F 026 402 118
N 2119	F 026 402 119
N 2120	F 026 402 120
N 2121	F 026 402 121
N 2122	F 026 402 122
N 2124	F 026 402 124
N 2125	F 026 402 125
N 2126	F 026 402 126
N 2127	F 026 402 127
N 2128	F 026 402 128
N 2134	F 026 402 134
N 2136	F 026 402 136
N 2138	F 026 402 138
N 2140	F 026 402 140
N 2143	F 026 402 143
N 2808	F 026 402 808
N 2809	F 026 402 809
N 2810	F 026 402 810
N 2811	F 026 402 811
N 2812	F 026 402 812
N 4050	1 457 434 050
N 4051	1 457 434 051
N 4060	0 450 904 060
N 4062	1 457 434 062
N 4077	0 450 904 077
N 4103	1 457 434 103
N 4105	1 457 434 105
N 4106	1 457 434 106
N 4123	1 457 434 123
N 4150	1 457 434 150
N 4153	1 457 434 153
N 4154	1 457 434 154
N 4156	1 457 434 156



 N°	
N 4158	0 450 904 158
N 4161	0 450 904 161
N 4165	1 457 434 165
N 4174	1 457 434 174
N 4180	1 457 434 180
N 4184	1 457 434 184
N 4186	1 457 434 186
N 4187	1 457 434 187
N 4192	1 457 434 192
N 4194	1 457 434 194
N 4198	1 457 434 198
N 4200	1 457 434 200
N 4201	1 457 434 201
N 4281	1 457 434 281
N 4291	1 457 434 291
N 4293	1 457 434 293
N 4294	1 457 434 294
N 4295	1 457 434 295
N 4296	1 457 434 296
N 4302	1 457 434 302
N 4306	1 457 434 306
N 4310	1 457 434 310
N 4314	1 457 434 314
N 4321	1 457 434 321
N 4324	1 457 434 324
N 4329	1 457 434 329
N 4331	1 457 434 331
N 4400	1 457 434 400
N 4402	1 457 434 402
N 4405	1 457 434 405
N 4408	1 457 434 408
N 4409	1 457 434 409
N 4416	1 457 434 416
N 4419	1 457 434 419
N 4421	1 457 434 421
N 4423	1 457 434 423
N 4428	1 457 434 428
N 4429	1 457 434 429
N 4432	1 457 434 432
N 4433	1 457 434 433
N 4435	1 457 434 435
N 4436	1 457 434 436
N 4437	1 457 434 437
N 4438	1 457 434 438
N 4439	1 457 434 439



 N°	
N 4440	1 457 434 440
N 4443	1 457 434 443
N 4447	1 457 434 447
N 4448	1 457 434 448
N 4450	1 457 434 450
N 4451	1 457 434 451
N 4452	1 457 434 452
N 4453	1 457 434 453
N 4454	1 457 434 454
N 4455	1 457 434 455
N 4456	1 457 434 456
N 4457	1 457 434 457
N 4459	1 457 434 459
N 4460	1 457 434 460
N 4510	1 457 434 510
N 4511	1 457 434 511
N 4516	1 457 434 516
N 5930	0 450 905 930
N 5942	0 450 905 942
N 6172	0 450 906 172
N 6174	0 450 906 174
N 6261	0 450 906 261
N 6267	0 450 906 267
N 6274	0 450 906 274
N 6281	0 450 906 281
N 6295	0 450 906 295
N 6308	0 450 906 308
N 6318	0 450 906 318
N 6322	0 450 906 322
N 6334	0 450 906 334
N 6357	0 450 906 357
N 6373	0 450 906 373
N 6374	0 450 906 374
N 6376	0 450 906 376
N 6406	0 450 906 406
N 6407	0 450 906 407
N 6409	0 450 906 409
N 6426	0 450 906 426
N 6429	0 450 906 429
N 6431	0 450 906 431
N 6437	0 450 906 437
N 6442	0 450 906 442
N 6450	0 450 906 450
N 6451	0 450 906 451
N 6452	0 450 906 452

- nl** Omzettingslijst
Opzoeknummer →
Bestelnummer
(vervolg)
- sv** Söknummer →
Artikelnummer
(fortsättning)
- cs** Převod vyhledávací číslo
→ objednáací číslo
(pokračování)
- pl** Zestawienie
numer identyfikacyjny →
numer katalogowy
(ciąg dalszy)
- ru** Соответствие Поисковый
номер → Номер артикула
(продолжение)

	
N 6453	0 450 906 453
N 6457	0 450 906 457
N 6458	0 450 906 458
N 6459	0 450 906 459
N 6460	0 450 906 460
N 6461	0 450 906 461
N 6462	0 450 906 462
N 6463	0 450 906 463
N 6464	0 450 906 464
N 6467	0 450 906 467
N 6468	0 450 906 468
N 6469	0 450 906 469
N 6473	0 450 906 473
N 6500	0 450 906 500
N 6503	0 450 906 503
N 6508	0 450 906 508
N 6511	0 450 906 511
N 7006	0 450 907 006
N 7007	0 450 907 007
N 7008	0 450 907 008
N 7011	0 450 907 011
N 7016	0 450 907 016
N 9225	1 457 429 225
N 9230	1 457 429 230
N 9289	1 457 429 289
N 9291	1 457 429 291
N 9354	1 457 429 354
N 9359	1 457 429 359
N 9621	1 457 429 621
N 9655	1 457 429 655
N 9656	1 457 429 656
N 9657	1 457 429 657
N 9675	1 457 429 675
N 9676	1 457 429 676
N 9681	1 457 429 681
P ...	
P 0003	0 451 300 003
P 0004	0 451 300 004
P 0005	0 451 300 005
P 0007	0 451 300 007
P 0008	0 451 300 008
P 1156	0 451 301 156
P 1207	0 451 301 207
P 2000	0 986 452 000

	
P 2005	0 986 452 005
P 2016	0 986 452 016
P 2019	0 986 452 019
P 2020	0 986 452 020
P 2023	0 986 452 023
P 2024	0 986 452 024
P 2028	0 986 452 028
P 2030	0 986 452 030
P 2035	0 986 452 035
P 2042	0 986 452 042
P 2044	0 986 452 044
P 2046	0 986 452 046
P 2058	0 986 452 058
P 2060	0 986 452 060
P 2061	0 986 452 061
P 2062	0 986 452 062
P 2063	0 986 452 063
P 2064	0 986 452 064
P 2066	0 986 452 066
P 2182	0 451 302 182
P 2400	0 986 452 400
P 3001	0 451 403 001
P 3002	0 451 203 002
P 3004	0 451 103 004
P 3005	0 451 203 005
P 3010	0 451 203 010
P 3028	0 451 103 028
P 3029	0 451 103 029
P 3038	0 451 103 038
P 3062	0 451 103 062
P 3077	0 451 403 077
P 3108	0 451 203 108
P 3109	0 451 103 109
P 3141	0 451 103 141
P 3144	0 451 103 144
P 3152	0 451 203 152
P 3194	0 451 203 194
P 3197	0 451 203 197
P 3201	0 451 203 201
P 3208	0 451 403 208
P 3210	0 451 403 210
P 3217	0 451 103 217
P 3220	0 451 203 220
P 3221	0 451 103 221
P 3223	0 451 203 223

	
P 3227/1	0 451 203 227
P 3228/1	0 451 203 228
P 3231	0 451 203 231
P 3232	0 451 103 232
P 3240	0 451 103 240
P 3249	0 451 103 249
P 3252	0 451 103 252
P 3253	0 451 103 253
P 3257	0 451 103 257
P 3258	0 451 103 258
P 3260	0 451 103 260
P 3270	0 451 103 270
P 3275	0 451 103 275
P 3276	0 451 103 276
P 3289	0 451 103 289
P 3290	0 451 103 290
P 3297	0 451 103 297
P 3311	0 451 103 311
P 3316	0 451 103 316
P 3330	0 451 103 330
P 3337	0 451 103 337
P 3341	0 451 103 341
P 3343	0 451 103 343
P 3346	0 451 103 346
P 3347	0 451 103 347
P 3357	0 451 103 357
P 3360	0 451 103 360
P 3365	0 451 103 365
P 3366	0 451 103 366
P 3368	0 451 103 368
P 4005	0 451 104 005
P 4010	0 451 104 010
P 4013	0 451 104 013
P 4015	0 451 104 015
P 4065	0 451 104 065
P 4066	0 451 104 066
P 4067	0 451 104 067
P 5067	0 451 105 067
P 5188	0 451 105 188
P 7001	1 457 437 001
P 7001/1	F 026 407 001
P 7002	1 457 437 002
P 7002/1	F 026 407 002
P 7003	1 457 437 003
P 7003/1	F 026 407 003

	
P 7014	F 026 407 014
P 7017	F 026 407 017
P 7018	F 026 407 018
P 7021	F 026 407 021
P 7023	F 026 407 023
P 7024	F 026 407 024
P 7025	F 026 407 025
P 7026	F 026 407 026
P 7027	F 026 407 027
P 7040	F 026 407 040
P 7042	F 026 407 042
P 7043	F 026 407 043
P 7044	F 026 407 044
P 7045	F 026 407 045
P 7046	F 026 407 046
P 7047	F 026 407 047
P 7048	F 026 407 048
P 7049	F 026 407 049
P 7051	F 026 407 051
P 7053	F 026 407 053
P 7054	F 026 407 054
P 7057	F 026 407 057
P 7058	F 026 407 058
P 7059	F 026 407 059
P 7060	F 026 407 060
P 7061	F 026 407 061
P 7062	F 026 407 062
P 7066	F 026 407 066
P 7068	F 026 407 068
P 7069	F 026 407 069
P 7070	F 026 407 070
P 7071	F 026 407 071
P 7072	F 026 407 072
P 7073	F 026 407 073
P 7076	F 026 407 076
P 7077	F 026 407 077
P 7083	F 026 407 083
P 7090	F 026 407 090
P 7091	F 026 407 091
P 7092	F 026 407 092
P 7093	F 026 407 093
P 7094	F 026 407 094
P 7095	F 026 407 095
P 7096	F 026 407 096
P 7097	F 026 407 097

de

Gegenüberstellung
Suchnummer →
Bestellnummer
(Fortsetzung)

en

Cross references
search number →
part number
(continued)

fr

Table de correspon-
dance code d'identi-
fication → référence
(suite)

it

Confronto codice breve →
codice di ordinazione
(seguito)

es

Confrontación refe-
rencia comercial →
referencia de pedido
(continuación)



P 7098	F 026 407 098
P 7099	F 026 407 099
P 7100	F 026 407 100
P 7101	F 026 407 101
P 7104	F 026 407 104

P 7105	F 026 407 105
P 7106	F 026 407 106
P 7108	F 026 407 108
P 7109	F 026 407 109
P 7112	F 026 407 112

P 7116	F 026 407 116
P 7118	F 026 407 118
P 7119	F 026 407 119
P 7122	F 026 407 122
P 7123	F 026 407 123

P 7125	F 026 407 125
P 7130	F 026 407 130
P 7143	F 026 407 143
P 7144	F 026 407 144
P 7147	F 026 407 147

P 9105	1 457 429 105
P 9107	1 457 429 107
P 9113	1 457 429 113
P 9117	1 457 429 117
P 9118	1 457 429 118

P 9119	1 457 429 119
P 9123	1 457 429 123
P 9126	1 457 429 126
P 9128	1 457 429 128
P 9130	1 457 429 130

P 9137	1 457 429 137
P 9139	1 457 429 139
P 9152	1 457 429 152
P 9154	1 457 429 154
P 9165	1 457 429 165

P 9167	1 457 429 167
P 9174	1 457 429 174
P 9175	1 457 429 175
P 9185	1 457 429 185
P 9194	1 457 429 194

P 9196	1 457 429 196
P 9198	1 457 429 198
P 9199	1 457 429 199
P 9238	1 457 429 238
P 9239	1 457 429 239



P 9248	1 457 429 248
P 9252	1 457 429 252
P 9267	1 457 429 267
P 9270	1 457 429 270
P 9271	1 457 429 271

P 9272	1 457 429 272
P 9274	1 457 429 274
P 9275	1 457 429 275
P 9276	1 457 429 276
P 9277	1 457 429 277

P 9284	1 457 429 284
P 9286	1 457 429 286
P 9302	1 457 429 302
P 9307	1 457 429 307
P 9308	1 457 429 308

P 9416	1 457 429 416
P 9546	1 457 429 546
P 9559	1 457 429 559
P 9600	1 457 429 600
P 9619	1 457 429 619

P 9629	1 457 429 629
P 9631	1 457 429 631
P 9636	1 457 429 636
P 9646	1 457 429 646
P 9647	1 457 429 647

P 9648	1 457 429 648
P 9649	1 457 429 649
P 9732	1 457 429 732
P 9735	1 457 429 735
P 9740	1 457 429 740

P 9820	1 457 429 820
--------	---------------

R ...

R 1451	1 987 431 451
R 1452	1 987 431 452
R 1454	1 987 431 454

R 1455	1 987 431 455
R 1456	1 987 431 456
R 1457	1 987 431 457
R 1458	1 987 431 458
R 2306	1 987 432 306



R 2319	1 987 432 319
R 2320	1 987 432 320
R 2383	1 987 432 383
R 2392	1 987 432 392
R 2394	1 987 432 394

R 2400	1 987 432 400
R 2406	1 987 432 406
R 2415	1 987 432 415
R 2416	1 987 432 416
R 2426	1 987 432 426

R 2435	1 987 432 435
R 2436	1 987 432 436
R 2464	1 987 432 464
R 2488	1 987 432 488
R 2498	1 987 432 498

R 2500	1 987 432 500
R 2513	1 987 432 513
R 2525	1 987 432 525
R 2531	1 987 432 531
R 2535	1 987 432 535

R 2542	1 987 432 542
R 2545	1 987 432 545
R 2548	1 987 432 548
R 2549	1 987 432 549
R 2566	1 987 432 566

R 2568	1 987 432 568
R 2571	1 987 432 571
R 2574	1 987 432 574
R 2598	1 987 432 598

S ...

S 0001	F 026 400 001
S 0006	F 026 400 006
S 0007	F 026 400 007

S 0012	F 026 400 012
S 0013	F 026 400 013
S 0014	F 026 400 014
S 0015	F 026 400 015
S 0016	F 026 400 016

S 0017	F 026 400 017
S 0019	F 026 400 019
S 0020	F 026 400 020
S 0022	F 026 400 022
S 0023	F 026 400 023



S 0024	F 026 400 024
S 0025	F 026 400 025
S 0027	F 026 400 027
S 0028	F 026 400 028
S 0033	F 026 400 033

S 0034	F 026 400 034
S 0037	F 026 400 037
S 0038	F 026 400 038
S 0040	F 026 400 040
S 0041	F 026 400 041

S 0043	F 026 400 043
S 0044	F 026 400 044
S 0045	F 026 400 045
S 0046	F 026 400 046
S 0048	F 026 400 048

S 0049	F 026 400 049
S 0051	F 026 400 051
S 0052	F 026 400 052
S 0054	F 026 400 054
S 0055	F 026 400 055

S 0056	F 026 400 056
S 0058	F 026 400 058
S 0059	F 026 400 059
S 0060	F 026 400 060
S 0061	F 026 400 061

S 0062	F 026 400 062
S 0064	F 026 400 064
S 0065	F 026 400 065
S 0067	F 026 400 067
S 0068	F 026 400 068

S 0069	F 026 400 069
S 0070	F 026 400 070
S 0071	F 026 400 071
S 0072	F 026 400 072
S 0073	F 026 400 073

S 0074	F 026 400 074
S 0075	F 026 400 075
S 0076	F 026 400 076
S 0077	F 026 400 077
S 0078	F 026 400 078

S 0079	F 026 400 079
S 0080	F 026 400 080
S 0082	F 026 400 082
S 0083	F 026 400 083
S 0084	F 026 400 084

nl	sv	cs	pl	ru
Omzettingslijst Opzoeknummer → Bestelnummer (vervolg)	Söknummer → Artikelnummer (fortsättning)	Převod vyhledávací číslo → objednáací číslo (pokračování)	Zestawienie numer identyfikacyjny → numer katalogowy (ciąg dalszy)	Соответствие Поисковый номер → Номер артикула (продолжение)



S 0085	F 026 400 085
S 0086	F 026 400 086
S 0087	F 026 400 087
S 0088	F 026 400 088
S 0090	F 026 400 090

S 0091	F 026 400 091
S 0092	F 026 400 092
S 0093	F 026 400 093
S 0094	F 026 400 094
S 0096	F 026 400 096

S 0097	F 026 400 097
S 0098	F 026 400 098
S 0101	F 026 400 101
S 0102	F 026 400 102
S 0103	F 026 400 103

S 0106	F 026 400 106
S 0107	F 026 400 107
S 0109	F 026 400 109
S 0110	F 026 400 110
S 0111	F 026 400 111

S 0113	F 026 400 113
S 0114	F 026 400 114
S 0117	F 026 400 117
S 0119	F 026 400 119
S 0121	F 026 400 121

S 0123	F 026 400 123
S 0125	F 026 400 125
S 0126	F 026 400 126
S 0127	F 026 400 127
S 0128	F 026 400 128

S 0129	F 026 400 129
S 0130	F 026 400 130
S 0132	F 026 400 132
S 0133	F 026 400 133
S 0135	F 026 400 135

S 0137	F 026 400 137
S 0138	F 026 400 138
S 0140	F 026 400 140
S 0143	F 026 400 143
S 0145	F 026 400 145

S 0147	F 026 400 147
S 0150	F 026 400 150
S 0153	F 026 400 153
S 0154	F 026 400 154
S 0158	F 026 400 158



S 0159	F 026 400 159
S 0160	F 026 400 160
S 0161	F 026 400 161
S 0162	F 026 400 162
S 0163	F 026 400 163

S 0165	F 026 400 165
S 0166	F 026 400 166
S 0167	F 026 400 167
S 0168	F 026 400 168
S 0169	F 026 400 169

S 0170	F 026 400 170
S 0171	F 026 400 171
S 0173	F 026 400 173
S 0174	F 026 400 174
S 0175	F 026 400 175

S 0176	F 026 400 176
S 0177	F 026 400 177
S 0179	F 026 400 179
S 0182	F 026 400 182
S 0183	F 026 400 183

S 0184	F 026 400 184
S 0186	F 026 400 186
S 0187	F 026 400 187
S 0188	F 026 400 188
S 0189	F 026 400 189

S 0190	F 026 400 190
S 0191	F 026 400 191
S 0192	F 026 400 192
S 0193	F 026 400 193
S 0194	F 026 400 194

S 0195	F 026 400 195
S 0196	F 026 400 196
S 0197	F 026 400 197
S 0199	F 026 400 199
S 0200	F 026 400 200

S 0201	F 026 400 201
S 0202	F 026 400 202
S 0203	F 026 400 203
S 0204	F 026 400 204
S 0205	F 026 400 205

S 0206	F 026 400 206
S 0207	F 026 400 207
S 0209	F 026 400 209
S 0210	F 026 400 210
S 0211	F 026 400 211



S 0212	F 026 400 212
S 0214	F 026 400 214
S 0217	F 026 400 217
S 0218	F 026 400 218
S 0219	F 026 400 219

S 0220	F 026 400 220
S 0221	F 026 400 221
S 0222	F 026 400 222
S 0223	F 026 400 223
S 0224	F 026 400 224

S 0225	F 026 400 225
S 0226	F 026 400 226
S 0227	F 026 400 227
S 0228	F 026 400 228
S 0229	F 026 400 229

S 0230	F 026 400 230
S 0231	F 026 400 231
S 0232	F 026 400 232
S 0234	F 026 400 234
S 0236	F 026 400 236

S 0243	F 026 400 243
S 0244	F 026 400 244
S 0245	F 026 400 245
S 0247	F 026 400 247
S 0249	F 026 400 249

S 0250	F 026 400 250
S 0251	F 026 400 251
S 0252	F 026 400 252
S 0255	F 026 400 255
S 0256	F 026 400 256

S 0257	F 026 400 257
S 0258	F 026 400 258
S 0261	F 026 400 261
S 0263	F 026 400 263
S 0264	F 026 400 264

S 0265	F 026 400 265
S 0266	F 026 400 266
S 0267	F 026 400 267
S 0268	F 026 400 268
S 0271	F 026 400 271

S 0272	F 026 400 272
S 0275	F 026 400 275
S 0276	F 026 400 276
S 0277	F 026 400 277
S 0278	F 026 400 278



S 0279	F 026 400 279
S 0280	F 026 400 280
S 0282	F 026 400 282
S 0283	F 026 400 283
S 0285	F 026 400 285

S 0286	F 026 400 286
S 0287	F 026 400 287
S 0288	F 026 400 288
S 0290	F 026 400 290
S 0291	F 026 400 291

S 0293	F 026 400 293
S 0294	F 026 400 294
S 0295	F 026 400 295
S 0296	F 026 400 296
S 0299	F 026 400 299

S 0304	F 026 400 304
S 0309	F 026 400 309
S 0310	F 026 400 310
S 0312	F 026 400 312
S 0314	F 026 400 314

S 0320	F 026 400 320
S 0322	F 026 400 322
S 0323	F 026 400 323
S 0327	F 026 400 327
S 0329	F 026 400 329

S 0330	F 026 400 330
S 2100	1 457 432 100
S 2106	1 457 432 106
S 2108	1 457 432 108
S 2110	1 457 432 110

S 2128	1 457 432 128
S 2138	1 457 432 138
S 2146	1 457 432 146
S 2149	1 457 432 149
S 2150	1 457 432 150

S 2185	1 457 432 185
S 2188	1 457 432 188
S 2192	1 457 432 192
S 2193	1 457 432 193
S 2208	1 457 432 208

S 2210	1 457 432 210
S 3003	1 457 433 003
S 3005	1 457 433 005
S 3006	1 457 433 006
S 3008	1 457 433 008

de

**Gegenüberstellung
Suchnummer →
Bestellnummer**
(Fortsetzung)

en

**Cross references
search number →
part number**
(continued)

fr



**Table de correspon-
dance code d'identi-
fication → référence**
(suite)



it



**Confronto codice breve →
codice di ordinazione**
(seguito)



es

**Confrontación refe-
rencia comercial →
referencia de pedido**
(continuación)

 N°	
S 3036	1 457 433 036
S 3037	1 457 433 037
S 3042	1 457 433 042
S 3044	1 457 433 044
S 3045	1 457 433 045
S 3053	1 457 433 053
S 3056	1 457 433 056
S 3058	1 457 433 058
S 3060	1 457 433 060
S 3061	1 457 433 061
S 3062	1 457 433 062
S 3066	1 457 433 066
S 3069	1 457 433 069
S 3070	1 457 433 070
S 3073	1 457 433 073
S 3083	1 457 433 083
S 3086	1 457 433 086
S 3089	1 457 433 089
S 3096	1 457 433 096
S 3098	1 457 433 098
S 3099	1 457 433 099
S 3152	1 457 433 152
S 3153	1 457 433 153
S 3154	1 457 433 154
S 3155	1 457 433 155
S 3160	1 457 433 160
S 3161	1 457 433 161
S 3163	1 457 433 163
S 3164	1 457 433 164
S 3200	1 457 433 200
S 3201	1 457 433 201
S 3204	1 457 433 204
S 3231	1 457 433 231
S 3232	1 457 433 232
S 3234	1 457 433 234
S 3252	1 457 433 252
S 3256	1 457 433 256
S 3259	1 457 433 259
S 3264	1 457 433 264
S 3266	1 457 433 266
S 3269	1 457 433 269
S 3273	1 457 433 273
S 3275	1 457 433 275
S 3282	1 457 433 282
S 3285	1 457 433 285

 N°	
S 3286	1 457 433 286
S 3290	1 457 433 290
S 3292	1 457 433 292
S 3294	1 457 433 294
S 3299	1 457 433 299
S 3303	1 457 433 303
S 3307	1 457 433 307
S 3308	1 457 433 308
S 3309	1 457 433 309
S 3314	1 457 433 314
S 3319	1 457 433 319
S 3322	1 457 433 322
S 3324	1 457 433 324
S 3326	1 457 433 326
S 3327	1 457 433 327
S 3330	1 457 433 330
S 3331	1 457 433 331
S 3332	1 457 433 332
S 3333	1 457 433 333
S 3334	1 457 433 334
S 3336	1 457 433 336
S 3337	1 457 433 337
S 3338	1 457 433 338
S 3339	1 457 433 339
S 3521	1 457 433 521
S 3531	1 457 433 531
S 3532	1 457 433 532
S 3533	1 457 433 533
S 3534	1 457 433 534
S 3535	1 457 433 535
S 3538	1 457 433 538
S 3539	1 457 433 539
S 3541	1 457 433 541
S 3542	1 457 433 542
S 3544	1 457 433 544
S 3548	1 457 433 548
S 3555	1 457 433 555
S 3557	1 457 433 557
S 3558	1 457 433 558
S 3564	1 457 433 564
S 3566	1 457 433 566
S 3568	1 457 433 568
S 3574	1 457 433 574
S 3577	1 457 433 577
S 3578	1 457 433 578

 N°	
S 3580	1 457 433 580
S 3584	1 457 433 584
S 3588	1 457 433 588
S 3589	1 457 433 589
S 3594	1 457 433 594
S 3595	1 457 433 595
S 3596	1 457 433 596
S 3601	1 457 433 601
S 3605	1 457 433 605
S 3610	1 457 433 610
S 3611	1 457 433 611
S 3616	1 457 433 616
S 3617	1 457 433 617
S 3620	1 457 433 620
S 3623	1 457 433 623
S 3624	1 457 433 624
S 3626	1 457 433 626
S 3627	1 457 433 627
S 3637	1 457 433 637
S 3646	1 457 433 646
S 3650	1 457 433 650
S 3651	1 457 433 651
S 3654	1 457 433 654
S 3655	1 457 433 655
S 3659	1 457 433 659
S 3670	1 457 433 670
S 3671	1 457 433 671
S 3677	1 457 433 677
S 3682	1 457 433 682
S 3688	1 457 433 688
S 3690	1 457 433 690
S 3702	1 457 433 702
S 3711	1 457 433 711
S 3712	1 457 433 712
S 3713	1 457 433 713
S 3722	1 457 433 722
S 3726	1 457 433 726
S 3728	1 457 433 728
S 3729	1 457 433 729
S 3730	1 457 433 730
S 3731	1 457 433 731
S 3734	1 457 433 734
S 3735	1 457 433 735
S 3741	1 457 433 741
S 3743	1 457 433 743

 N°	
S 3745	1 457 433 745
S 3750	1 457 433 750
S 3769	1 457 433 769
S 3772	1 457 433 772
S 3773	1 457 433 773
S 3775	1 457 433 775
S 3784	1 457 433 784
S 3785	1 457 433 785
S 3786	1 457 433 786
S 3789	1 457 433 789
S 3790	1 457 433 790
S 3792	1 457 433 792
S 3795	1 457 433 795
S 3797	1 457 433 797
S 3799	1 457 433 799
S 3800	1 457 433 800
S 3900	1 457 433 900
S 3901	1 457 433 901
S 3903	1 457 433 903
S 3904	1 457 433 904
S 3952	1 457 433 952
S 3953	1 457 433 953
S 3954	1 457 433 954
S 3955	1 457 433 955
S 3956	1 457 433 956
S 3957	1 457 433 957
S 3958	1 457 433 958
S 3959	1 457 433 959
S 3961	1 457 433 961
S 3962	1 457 433 962
S 3963	1 457 433 963
S 3965	1 457 433 965
S 3966	1 457 433 966
S 3968	1 457 433 968
S 3969	1 457 433 969
S 3970	1 457 433 970
S 3971	1 457 433 971
S 3972	1 457 433 972
S 6789	0 986 626 789
S 6791	0 986 626 791
S 9004	1 987 429 004
S 9012	1 987 429 012
S 9030	1 457 429 030
S 9036	1 987 429 036
S 9040	1 987 429 040

nl	sv	cs	pl	ru
Omzettingslijst Opzoeknummer → Bestelnummer (vervolg)	Söknummer → Artikelnummer (fortsättning)	Převod vyhledávací číslo → objednáací číslo (pokračování)	Zestawienie numer identyfikacyjny → numer katalogowy (ciąg dalszy)	Соответствие Поисковый номер → Номер артикула (продолжение)



S 9042/1	1 987 429 042
S 9046	1 987 429 046
S 9050	1 457 429 050
S 9051	1 987 429 051
S 9053	1 457 429 053

S 9054	1 457 429 054
S 9064	1 457 429 064
S 9066	1 457 429 066
S 9078	1 457 429 078
S 9107	1 987 429 107

S 9109	1 987 429 109
S 9115	1 987 429 115
S 9117	1 987 429 117
S 9120	1 987 429 120
S 9121	1 987 429 121

S 9122	1 987 429 122
S 9123	1 987 429 123
S 9125	1 987 429 125
S 9127	1 987 429 127
S 9128	1 987 429 128

S 9133	1 987 429 133
S 9135	1 987 429 135
S 9136	1 987 429 136
S 9137	1 987 429 137
S 9146	1 987 429 146

S 9148	1 987 429 148
S 9149	1 987 429 149
S 9150	1 987 429 150
S 9151	1 987 429 151
S 9152	1 987 429 152

S 9154	1 987 429 154
S 9155	1 987 429 155
S 9156	1 987 429 156
S 9157	1 987 429 157
S 9158	1 987 429 158

S 9159	1 987 429 159
S 9161	1 987 429 161
S 9162	1 987 429 162
S 9163	1 987 429 163
S 9164	1 987 429 164

S 9167	1 987 429 167
S 9169	1 987 429 169
S 9170	1 987 429 170
S 9171	1 987 429 171
S 9172	1 987 429 172



S 9173	1 987 429 173
S 9174	1 987 429 174
S 9175	1 987 429 175
S 9176	1 987 429 176
S 9177	1 987 429 177

S 9178	1 987 429 178
S 9179	1 987 429 179
S 9180	1 987 429 180
S 9182	1 987 429 182
S 9183	1 987 429 183

S 9184	1 987 429 184
S 9185	1 987 429 185
S 9186	1 987 429 186
S 9187	1 987 429 187
S 9191	1 987 429 191

S 9192	1 987 429 192
S 9775	1 457 429 775
S 9781	1 457 429 781
S 9789	1 457 429 789
S 9791	1 457 429 791

S 9792	1 457 429 792
S 9793	1 457 429 793
S 9794	1 457 429 794
S 9800	1 457 429 800
S 9801	1 457 429 801

S 9806	1 457 429 806
S 9810	1 457 429 810
S 9817	1 457 429 817
S 9819	1 457 429 819
S 9821	1 457 429 821

S 9840	1 457 429 840
S 9842	1 457 429 842
S 9845	1 457 429 845
S 9846	1 457 429 846
S 9854	1 457 429 854

S 9871	1 457 429 871
S 9873	1 457 429 873
S 9874	1 457 429 874
S 9875	1 457 429 875
S 9876	1 457 429 876

S 9882	1 457 429 882
S 9886	1 457 429 886
S 9893	1 457 429 893
S 9894	1 457 429 894
S 9895	1 457 429 895



S 9899	1 457 429 899
S 9920	1 457 429 920
S 9932	1 457 429 932
S 9933	1 457 429 933
S 9934	1 457 429 934

S 9941	1 457 429 941
S 9942	1 457 429 942
S 9946	1 457 429 946
S 9950	1 457 429 950
S 9954	1 457 429 954

S 9959	1 457 429 959
S 9966	1 457 429 966
S 9969	1 457 429 969
S 9975	1 457 429 975
S 9979	1 457 429 979

S 9980	1 457 429 980
S 9983	1 457 429 983
S 9988	1 457 429 988
S 9991	1 457 429 991
S 9998	1 457 429 998

Z ...	
Z 4004	F 026 404 004



